

PRINCE CONTROL VALVES

H1

Prince™ - SV Standard Series Sectional Directional Control Valves

Pressure Rating: Maximum Operation Pressure: 3000 PSI, Maximum Tank Pressure: 500 PSI, Nominal Flow Rating: 12 GPM

BAUM SEQ. NO.	PART NO.	DESCRIPTION	PORT SIZE	PRICE PER PIECE
PRINCE - INLET SECTIONS - All have both top and side inlet ports				
178202	SVI21	No relief	#10 SAE ORB	\$68.05
178204	SVI24	Adjustable low pressure relief set at 1000 PSI	#10 SAE ORB	82.48
178206	SVI15	Adjustable high pressure relief set at 2000 PSI	#8 SAE ORB	89.27
178208	SVI25	Adjustable high pressure relief set at 2000 PSI	#10 SAE ORB	96.71

PRINCE - WORK SECTIONS - All have load check and standard lever handle				
178210	SVW1AA1	3-Way Single Acting w/ Spring Center	#8 SAE ORB	126.18
178212	SVW1BA1	4-Way Double Acting w/ Spring Center	#8 SAE ORB	135.18
178214	SVW1BB1	4-Way Double Acting w/ 3 Position Detent	#8 SAE ORB	149.87
178216	SVW1CA1	4-Way Motor Spool w/ Spring Center	#8 SAE ORB	133.21
178218	SVW1CB1	4-Way Motor Spool w/ 3 Position Detent	#8 SAE ORB	165.06
178220	SVW1DD1	4-Way 4 Position Float w/ Spring Center	#8 SAE ORB	167.75
178222	SVL1CA1	4-Way 4 Spool w/ Spring Center	#8 SAE ORB	212.64
178224	SVM1ES1	4-Way Meter Spool w/ Spring Center	#8 SAE ORB	127.05

PRINCE - OUTLET SECTION - All have both top and side outlet ports				
178226	SVE11	Open Center Outlet w/ Conversion Plug	#8 SAE ORB	61.34
178228	SVE21	Open Center Outlet w/ Conversion Plug	#10 SAE ORB	66.31
178230	SVE22	Power Beyond Outlet w/ #8 SAE Beyond Port	#10 SAE ORB	72.81
178232	SVE23	Closed Center Outlet	#10 SAE ORB	76.12
178234	SVE26	Open Center Outlet Pressure Build-up Valve	#10 SAE ORB	105.61
178236	SVE27	Poer Beyond Pressure Build-up Valve	#10 SAE ORB	95.87



SVI15 Inlet



SVW1BA1
Work Section



SVE11 Outlet

ACCESSORIES for Prince™ SV Standard Series

BAUM SEQ. NO.	PART NO.	DESCRIPTION	PRICE PER PIECE
PRINCE - TIE ROD KITS			
(Torque 150 in-lbs ± 6 in-lbs or 12-1/2 ft-lbs ± 1/2)			
178238	660401001	One Work Section	\$19.70
178240	660401002	Two Work Section	23.40
178242	660401003	Three Work Section	24.44
178244	660401004	Four Work Section	25.62
178246	660401005	Five Work Section	24.73
178248	660401006	Six Work Section	27.84
178250	660401007	Seven Work Section	26.36
178252	660401008	Eight Work Section	30.21
178254	660401009	Nine Work Section	28.66
178256	660401010	Ten Work Section	32.51

PRINCE - SPOOL ATTACHMENT KITS			
178258	660180001	Spring Center Kit	33.18
178260	660180002	3 Position Detent Kit	66.50
178262	660180003	Friction Detent Kit	61.47
178264	660180051	Float Detent kit	86.20

BAUM SEQ. NO.	PART NO.	DESCRIPTION	PRICE PER PIECE
PRINCE - HANDLE KITS			
178266	660180011	Standard Handle Kit	18.07
178268	660180032	Clevis Sub-Assembly	12.22
178270	660180005	Complete Handle Kit	37.32
178272	660180031	Pin Kit	8.74

PRINCE - SEAL KITS			
178274	660580001	SVW/SVM Replacement Seal Kit	10.22
178276	660580002	Inlet Seal Kit	9.63
178278	660580003	Outlet Seal Kit	9.33
178280	660580004	Between Section Seal Kit	3.70

PRINCE - INLET RELIEFS			
178282	660250006	Inlet Relief Plug	25.62
178284	660250003	Low Pressure Inlet Relief	59.54
178286	660250002	High Pressure Inlet Relief	59.54

PRINCE - OUTLET CARTRIDGES			
178288	200400030	Open Center Plug	6.22
178290	660280001	#8 SAE Power Beyond Cart	37.03
178292	660280002	Closed Center Plug	25.03

Prices subject to change without notice. **ASK FOR QUANTITY DISCOUNT**

1-800-228-9222 / e-mail: sales@baumhydraulics.com
 Fax: 1-800-832-2522 / www.baumhydraulics.com / © Baum Hydraulics Corporation

BAUM HYDRAULICS CORPORATION

PRINCE CONTROL VALVES



Prince™ - RD Series Directional Control Valves

SPECIFICATIONS: Includes Conversion Plug and End Tank Outlet. No Top Tank Outlet. Built-In Adjustable Relief Valve with Reversible Control Handle. Three 3/8 inch Mounting Holes in Base.

GPM - 25 Maximum Pressure - 3000 PSI Relief Setting - Adjustable

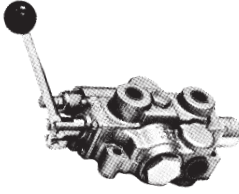

RD Series

Standard One Spool
Standard Two Spool
Standard Three Spool
With Float
on First Spool

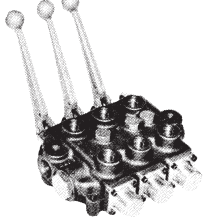
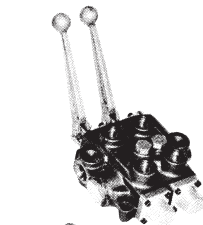

Joystick for Prince
Two Spool
valves ONLY
RD523CCAA5A4B1
or
RD523GCGA5A4B1

BAUM SEQ. NO.	PART NO.	NO. OF SPOOLS	SPOOL TYPE	SPOOL ACTION	INLET/OUTLET	CYL. PORTS	PRICE PER PIECE
PRINCE - RD Series Directional Control Valves							
178445	RD512CA5A4B1	1	4-way, 3-pos. tandem center	Single Spool: 3 pos., spring center to neutral	3/4" NPT Side	1/2" NPT Top	\$210.36
178446	RD522CCAA5A4B1	2	Both Spools: 4-way, 3-pos. tandem center	Both Spools: 3 pos., spring center to neutral	3/4" NPT Side	1/2" NPT Top	\$352.58
178447	RD532CCCAA5A4B1	3	All Spools: 4-way, 3-pos. tandem center	All Spools: 3 pos., spring center to neutral	3/4" NPT Side	1/2" NPT Top	\$500.89
178460	RD513CA5A4B1	1	4-way, 3-pos. tandem center	Single Spool: 3 pos., spring center to neutral	3/4" NPT Side	3/4" NPT Top	\$210.36
178461	RD523CCAA5A4B1	2	Both Spools: 4-way, 3-pos. tandem center	Both Spools: 3 pos., spring center to neutral	3/4" NPT Side	3/4" NPT Top	\$352.58
178462	RD533CCCAA5A4B1	3	All Spools: 4-way, 3-pos. tandem center	All Spools: 3 pos., spring center to neutral	3/4" NPT Side	1/2" NPT Top	\$476.89
178454	RD513GG5A4B1	1	Double Acting with Built-in Float	Single Spool: 4 pos., spring center to neutral	3/4" NPT Side	3/4" NPT Top	\$245.11
178456	RD523GCGA5A4B1	2	1 Double Acting with Built-in Float and 1 Double-Acting	Single Spool: 4 pos., spring center to neutral	3/4" NPT Side	3/4" NPT Top	\$370.46
178458	RD533GCGAA5A4B1	3	1 Double Acting with Built-in Float and 2 Double-Acting	Single Spool: 4 pos., spring center to neutral	3/4" NPT Side	3/4" NPT Top	\$501.51

PRINCE - Joystick for RD Valves

178377	660150011	2	---	Joystick Handle - Straight	---	---	\$ 200.87
178375	660150012	2	---	Joystick Handle - 45 Degree	---	---	\$ 203.40

PRINCE - Accessories for RD Valves

178392	660312004			Power Beyond Sleeve			\$26.66
178382	660150002			3-Position Detent Kit - No Spring			\$78.65
178383	660150003			Friction Detent Kit			\$74.78
178385	660150018			1-Position Detent Kit OUT w/ spring center			\$153.83
178394	660312005			Closed Center Plug			\$29.19
178282	660250006			No Relief Plug			\$25.62
EE2152	660551001			Seal Kit for 1 Spool Valve			\$7.43
EE2154	660552001			Seal Kit for 2 Spool Valve			\$10.33
EE2156	660553001			Seal Kit for 3 Spool Valve			\$14.90
178384	660150004			Handle Assembly			\$15.06
178380	660150001			Centering Spring (only) to Neutral			\$34.52
178284	660250003			Low Pressure Relief - 500-1500 PSI SP & SPK - Cartridge for SP			\$59.54

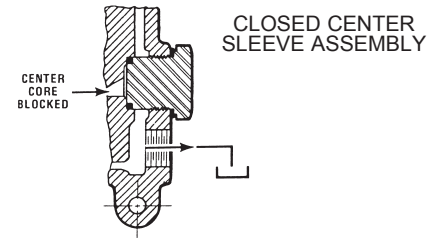
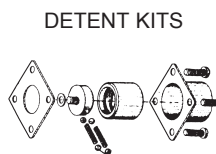
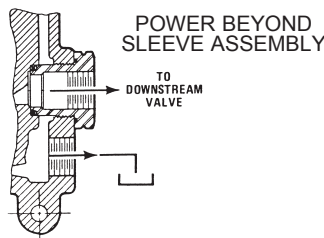

ASK FOR QUANTITY DISCOUNT Prices subject to change without notice.

CROSS CONTROL VALVES

H3

Cross Motors - BA Series & Converta Series Directional Control Valves

SPECIFICATIONS: Includes Conversion Plug and End Tank Outlet. No Top Tank Outlet. BA Series has Three 3/8 inch Mounting Holes in Base.

GPM - 25 Maximum Pressure - 2000 PSI

Relief Setting - Converta Series Adjustable, BA Series Relief Set at 1500 PSI

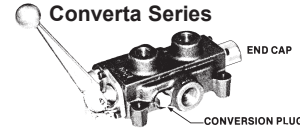

BA Series

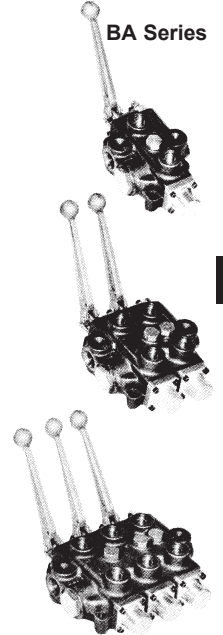

BAUM SEQ. NO.	PART NO.	NO. OF SPOOLS	SPOOL TYPE	SPOOL ACTION	INLET/ OUTLET	CYL. PORTS	PRICE PER PIECE
CROSS - BA & CONVERTA Series Directional Control Valves							
172805	CONVERTA	1	Double Acting	Self Centering Type	3/4" NPT Side	1/2" NPT Top	\$180.01
172798	BA11AG3EAO	1	Double Acting	Self Centering Type	3/4" NPT Side	1/2" NPT Top	\$242.50
172805	CONVERTA	1	Single Acting	Self Centering Type	3/4" NPT Side	1/2" NPT Top	\$180.01
172800	BA15BG3EAO	1	Double Acting with Detent	Free-Wheeling	3/4" NPT Side	1/2" NPT Top	\$305.15
172801	BA15AG3EAO	1	Double Acting	Free-Wheeling	3/4" NPT Side	1/2" NPT Top	\$274.50
173058	BA211AAG3EAO	2	Double Acting	Self Centering Type	3/4" NPT Side	1/2" NPT Top	\$368.93
173078	BA311AAAG3EAO	3	Double Acting	Self Centering Type	3/4" NPT Side	1/2" NPT Top	\$488.45
173888	BA2A1XAG3EAO	2	Double Acting with Built-in Float	Single Spool: 4 pos., spring center to neutral	3/4" NPT Side	1/2" NPT Top	\$389.37
173970	BA3A11XAAG3EAO	3	1 Double Acting with Built-in Float and 2 Double-Acting	Single Spool: 4 pos., spring center to neutral	3/4" NPT Side	1/2" NPT Top	\$545.30

CROSS - Accessories for BA Valves

726656	1V0208	Power Beyond Sleeve					\$21.99
727040	1V0294	3-Position Detent Kit - No Spring					\$50.18
726976	1V0558	Friction Detent Kit					\$74.10
727104	1V0559	1-Position Detent Kit OUT					\$78.25
726592	1V0206	Closed Center Plug					\$34.17
726500	1R0035	No Relief Plug					\$21.25
EE2112	2V0008	Seal Kit for 1 Spool Valve					\$1.54
EE2114	2V0009	Seal Kit for 2 Spool Valve					\$1.92
EE2116	2V0010	Seal Kit for 3 Spool Valve					\$2.41
727360	4Z4306	Cross Handle Bracket					7.61
727424	1V1703 PLUS	Handle Only					\$24.54
727488	1V1701 for BA	Pin Kit					\$8.60
727552	1V1702 for CA	Pin Kit					\$8.60
727770	1A0768	Knob for Selector Valve					\$4.81
726720	1A0744	Centering Spring (only) to Neutral					\$3.97
726715	1V1225	Centering Spring Kit					\$30.21
728388	1R0016	Low Pressure Relief - 500-1500 PSI SP & SPK - Cartridge for SP					\$40.49
726464	1R0017	High Pressure Relief - 1500-3000 PSI SP & SPK - Cartridge for SP					\$46.15



Model BA15BG3EAO

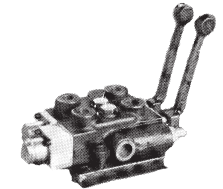

Two Spool and Three Spool All Double Acting with 4 Position Float on the First Spool

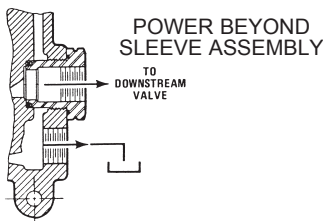

POWER BEYOND SLEEVE ASSEMBLY

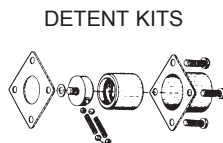

DETENT KITS

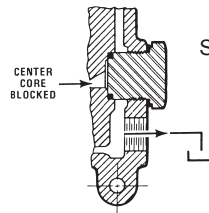

CLOSED CENTER SLEEVE ASSEMBLY

Prices subject to change without notice. **ASK FOR QUANTITY DISCOUNT**

1-800-228-9222 / e-mail: sales@baumhydraulics.com
 Fax: 1-800-832-2522 / www.baumhydraulics.com / © Baum Hydraulics Corporation

BAUM HYDRAULICS CORPORATION

CONTROL VALVES



Prince™ - LS Series Hydraulic Directional Control Valves

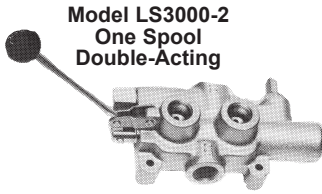

**Model LS3000-2
One Spool
Double-Acting**

BAUM SEQ. NO.	PART NO.	DESCRIPTION	CAP. GALLON	WT. LBS.	PRICE PER PIECE
178448	LS3000-2	Double-Acting	25	--	\$173.34

PRINCE - KNOCK-OUT VALVES

SPECIFICATIONS:

Capacity -	25 Gallons	Pressure Relief Detent Setting -	600 to 2000 PSI
Maximum Pressure -	2750 PSI	Inlet & Outlet Ports -	3/4 inch Pipe Thread
Relief Setting -	2250 PSI	Cylinder Ports -	3/4 inch Pipe Thread
		Three 11/32 inch Mounting Holes in Base	



**Model LS755C4JSHA
One Spool
Double-Acting**

BAUM SEQ. NO.	PART NO.	DESCRIPTION	CAP. GALLON	WT. LBS.	PRICE PER PIECE
176010	LS755C4JSHA	Double-Acting	18	5.5	\$278.76

PRINCE - KICK-OUT CONTROL VALVE - Closed Center - No Relief

SPECIFICATIONS:

Capacity -	25 Gallons	Inlet & Outlet Ports -	3/4 inch Pipe Thread
Maximum Pressure -	3000 PSI	Work Ports -	1/2 inch Pipe Thread

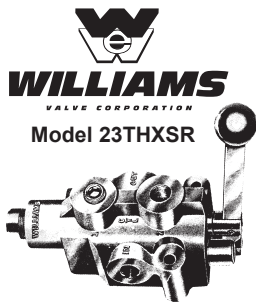

Model 23THXSR

Williams - Control Valves

SPECIFICATIONS: 4500 PSI Max. Pressure, Relief Set at 2500 PSI, 3/8" Ports

BAUM SEQ. NO.	PART NO.	DESCRIPTION	GPM	WT. LBS.	PRICE PER PIECE
177728	23THXSR	1 Spool For Double Acting Cylinders	9	9	\$289.48
177795	1314	Repair Kit	---	---	45.53

WILLIAMS - CONTROL VALVES

METRO

Metro - D2 Series Float Position Medium Control Valves

SPECIFICATIONS: Not sure on copy for specifications - Not sure on copy for specifications - Not sure on copy for specifications ???????

GPM - 6 Maximum Pressure - 2000 PSI Relief Setting - Adjustable

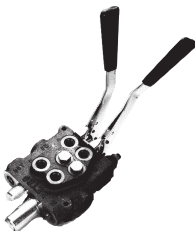

**6 GPM Relief 2000
Standard Two Spool
All Ports
9/16-18 o-ring**

BAUM SEQ. NO.	PART NO.	NO. OF SPOOLS	SPOOL TYPE	SPOOL ACTION	INLET/OUTLET	CYL. PORTS	PRICE PER PIECE
704990	D2CF1T2J	2	1 Double Acting with Built-in Float and 2 Double-Acting	Single Spool: 4 pos.,	9/16-18 o-ring	9/16-18 o-ring	\$509.82
704992	M-PB			Power Beyond Sleeve for Metro			\$19.19
704991	M-CC			Closed Center Plug for Metro			\$25.71

METRO - D2 Series Float Position Medium Hydraulic Control Valves

ASK FOR QUANTITY DISCOUNT

Prices subject to change without notice.

PRINCE MONOBLOCK VALVES

H5

Prince™ - 8 GPM Monblock Valves

PRODUCT FEATURES: 1-6 Spool monoblock, Convertible to power beyond and closed center capability, Interchangeable motor spool, #8 O-ring In/Out Ports, #8 Work Ports, Double acting, Load check, Closed center plug, Enclosed handle

GPM - 8 Maximum Pressure - 3500 PSI Relief Setting - Adjustable

BAUM SEQ. NO.	PART NO.	# OF SPOOLS / TYPE / ACTION	PRICE PER PIECE
PRINCE - 8 GPM MONOBLOCK VALVES			
178468	MB11B5CI	1 Spool Spring Center	\$155.87
178470	MB11C5CI	1 Spool for Motor 3 Position Detent	\$190.45
178472	MB21BB5CI	2 Spool Spring Center	\$246.88
178474	MB21GB5CI	2 Spool Float with Detent & Spring Center	\$346.26
178476	MB31BBB5CI	3 Spool Spring Center	\$378.37
178478	MB41BBBB5CI	4 Spool Spring Center	\$436.34
178480	MB52BBBBB5CI	5 Spool Spring Center	\$550.32
178482	MB61BBBBBB5CI	6 Spool Spring Center	\$651.56

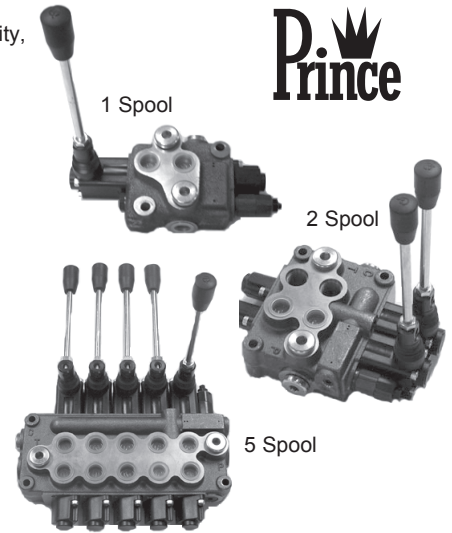

Prince

Prince™ - Control Valves with Closed Center Plug Included

PRODUCT FEATURES: Valves have a load check, a complete lever handle assembly, and an adjustable ball-spring relief set at 1500 PSI/12 GPM. Convertible from open center to closed center with included plug. Use with system flows to 20 GPM and pressures to 3000 PSI. 3/4 NPTF In/Out Ports and 1/2 NPTF Work Ports.

GPM - 20 Maximum Pressure - 3000 PSI Relief Setting - Adjustable

BAUM SEQ. NO.	PART NO.	# OF SPOOLS / TYPE / ACTION	PRICE PER PIECE
PRINCE - CONTROL VALVES WITH CLOSED CENTER PLUG INCLUDED			
178440	RD-2575-T4-ESA1	4 Way Tandem Center	\$149.14
178442	RD-2575-T3-ESA1	3 Way Tandem Center	\$172.83
178444	RD-2575-M4-ESA1	4 Way Motor Spool	\$155.46
178376	660125001	Dentent Kit	\$37.12
178378	660125002	Sprint Center Kit	\$10.26
178379	660525001	Seal Kit	\$8.62

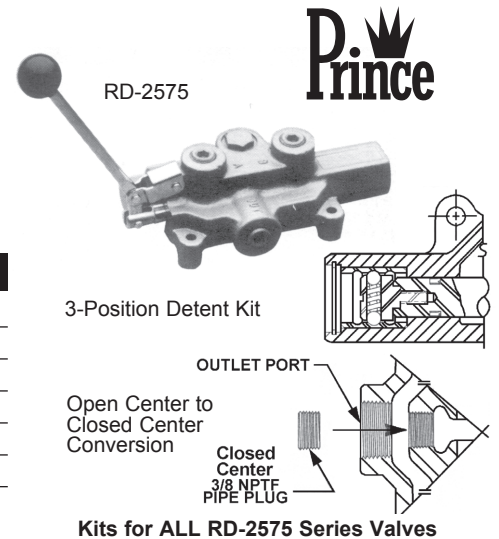

Prince

Prince™ - LVR and LVT Two Spool Monoblock Loader Valve

SPECIFICATIONS:

Parallel Circuit
 Maximum Operating Pressure 3000 PSI Maximum Operating Temperature 180° F
 Maximum Tank Pressure 500 PSI Recommended System Filtration ISO 4406 17/14

BAUM SEQ. NO.	PART NO.	# OF SPOOLS / TYPE / ACTION	PRICE PER PIECE
PRINCE - LVR & LVT TWO SPOOL MONOBLOCK LOADER VALVE			
178449	LVR1GR5AB7	14 GPM - 2 Spool A1 & B1:4-way, 4-pos. Float, spring center; A2 & B2: 4-way, 4-pos. regen, spring center	\$563.77
178450	LVT1GR5AB7	10 GPM - 2 Spool A1 & B1:4-way, 4-pos. Float, spring center; A2 & B2: 4-way, 4-pos. regen, spring center	\$509.05
178294	660280004	No Relief Plug for SV & LVR Valve	\$15.26
178295	660180111	Center Plug for LVR Valve	\$45.17



Prince

Prices subject to change without notice. **ASK FOR QUANTITY DISCOUNT**

1-800-228-9222 / e-mail: sales@baumhydraulics.com
 Fax: 1-800-832-2522 / www.baumhydraulics.com / © Baum Hydraulics Corporation

BAUM HYDRAULICS CORPORATION

PRINCE SECTIONAL DIRECTIONAL CONTROL VALVES



Prince™ - Series 20 Sectional Directional Control Valves

SPECIFICATIONS: Parallel or Tandam Circuit Construction

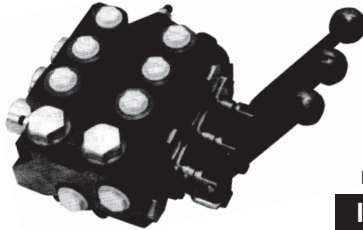

Model 20

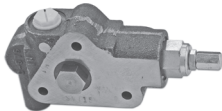

20I2G Inlet



20P1AA1AA Work Section



20E21 Outlet

Pressure Rating:

Maximum Operation Pressure	3500 PSI
Maximum Tank Pressure	500 PSI
Nominal Flow Rating	20 GPM
Refer to Pressure Drop Curves	

Maximum Operating Temperature 180°

Foot Mounting Weight Per Section

Inlet Section	Approx. 6.0 lbs.
Outlet Section	Approx. 3.5 lbs.
Work Section (Standard)	Approx. 9.0 lbs.

Filtration: Fluid cleanliness should meet the ISO 4406 17/14 level. As a minimum, 10 micron filtration is recommended.

PART NO.	DESCRIPTION	PRICE PER PIECE
INLET SECTIONS All have both top and side inlet ports		
20I2G	Adjustable low pressure relief set at 1750 PSI - Port size 1-1/16 O Ring Ports	167.96
20I2H	Adjustable high pressure relief set at 2200 PSI - Port size 1-1/16 O Ring Ports	180.89
20I2J	Adjustable high pressure relief set at 2500 PSI - Port size 1-1/16 O Ring Ports	189.88
WORK SECTION All have 7/8 oring ports, load check and standard lever handle		
20P1AA1AA	3-Way Single Acting w/ Spring Center	242.33
20P1BA1AA	4-Way Double Acting w/ Spring Center (Work Ports Blocked in Neutral)	231.25
20P1BB1AA	4-Way Double Acting w/ 3 Position Detent (Work Ports Blocked in Neutral)	222.36
20P1CA1AA	4-Way Motor Spool w/ Spring Center (Work Ports Open to Tank in Neutral)	224.94
20P1CB1AA	4-Way Motor Spool w/ 3 Position Detent (Work Ports Open to Tank in Neutral)	251.01
20P1DD1DD	4-Way 4 Position Float w/ Spring Center and Float Detent	402.00
20L1CA1	4-Way Spool w/ Spring Center (with Pilot Operated Checks on Both Work Ports)	306.91
OUTLET SECTION All have both top and side outlet ports		
20E21	Open Center Outlet w/ Conversion Plug - Port size 1-1/16 O Ring Ports	82.01
20E22	Power Beyond Outlet w/ #10 SAE Beyond Port - Port size 1-1/16 O Ring Ports	103.84
20E23	Closed Center Outlet - Port size 1-1/16 O Ring Ports	83.62

PART NO.	DESCRIPTION	PRICE PER PIECE
TIE ROD KITS (Torque 360 inch pounds or 30 - 32 foot-pounds)		
660402001	One Work Section	26.36
660402002	Two Work Sections	30.07
660402003	Three Work Sections	32.71
660402004	Four Work Sections	35.96
660402005	Five Work Sections	43.09
660402006	Six Work Sections	43.63
660402007	Seven Work Sections	50.38
660402008	Eight Work Sections	56.73
660402009	Nine Work Sections	60.45
660402010	Ten Work Sections	73.08

PART NO.	DESCRIPTION	PRICE PER PIECE
SPOOL ATTACHMENT KITS		
660190003	Spring Center Kit	37.51
660190004	3 Position Detent Kit	45.88
660190005	Friction Detent Kit	45.88

PART NO.	DESCRIPTION	PRICE PER PIECE
HANDLE KITS		
660190002	Standard Handle Kit	41.08
660190007	Complete Handle Kit	47.28

PART NO.	DESCRIPTION	PRICE PER PIECE
SEAL KITS		
660585002	Inlet Seal Kit	10.54
660585003	Outlet Seal Kit	10.85
660585004	Between Section Seal Kit	10.08
INLET RELIEFS		
660290001	No Relief Plug	22.94
660290203	Low Pressure Inlet Relief - Set at 1750 PSI	115.32
660290207	High Pressure Inlet Relief - Set at 2500 PSI	115.32
OUTLET CARTRIDGES		
660290006	Open Center Plug	12.71
660290004	Power Beyond Cart with 7/8 oring port	27.36
660290005	Closed Center Plug	24.65

ASK FOR QUANTITY DISCOUNT Prices subject to change without notice.

PARKER SECTIONAL DIRECTIONAL CONTROL VALVES

H7



Parker/Gresen - Sectional Directional Control Valves
SOLD IN INDIVIDUAL SECTIONS, BOLT & HANDLES SOLD SEPARATELY
ORDER RELIEF VALVE SET AT 2500 PSI.

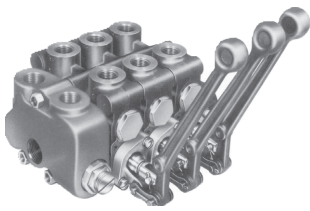

V20 VALVE 30 GPM 3500 PSI
 With Top and Side Ports
 1-1/16" O-Ring Inlet
 1-1/16" O-Ring Outlet

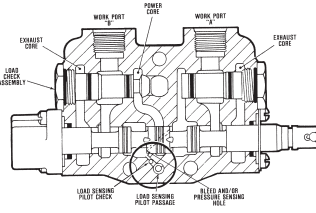

V20LS VALVE 30 GPM 3000 PSI
 Rating at work port with valve spool in neutral: 5000 PSI
 Capacity: Normal: 20 GPM
 Max Exhaust Core Pressure:
 With std spool seal retainer: 200 PSI
 Filtration Required: 33 micrometre

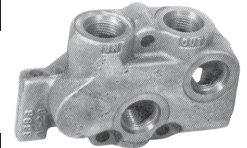

MODEL V20P
 LEFT INLET COVER
 for V20

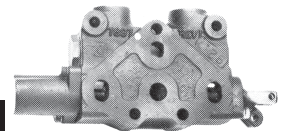

(8072 Section)
 20-10-03, 20-10-04,
 20-10-DF4,
 20-10-K04-2000,
 20-10-K4

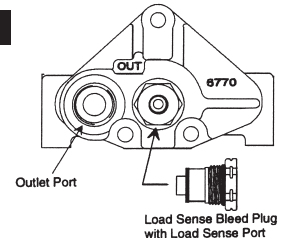

Outlet Cover
 w/ Bleed Port

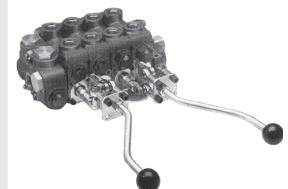

MJ2 Handle
 Assembly

30 GAL. V20 VALVE		30 GAL. V20LS VALVE	
Part No.	Price Per Piece	Part No.	Price Per Piece

INLET SECTION LEFT SIDE WITHOUT RELIEF VALVE Must order Relief Valve Cartridge

Cover Plate with end and top inlet & outlet	20-LC-12	\$167.96	20-LC-12	\$167.96
Cover Plate with built-in Flow Control	20-LC-12-FC	635.55	-----
Plug the Outlet in these Left Cover Plates if you use the Outlet in the Right Cover Plate. No Relief Plug Needed for Load Sense Inlet Cover	-----	K-20-NR	37.32

CENTER SECTION

With Double-Acting Spool 4-way	20-10-04	283.93	20LS-10-04	394.57
With Double-Acting Spool, 4-way, Big Ports	20-R12-04	197.55	-----
With Single-Acting Spool 3-way	20-10-03	197.55	20LS-10-03	259.57
*Spring return to neutral, SAE 10 ports, 4-way,	20S-10-04	516.81	-----
With Double-Acting Spool & Float, 4-way	20-10-K4	251.94	20LS-10-K4	358.74
With Dble-Act Spool-Detent & Free Flow for motors	20-10-DF4	242.18	-----
With Dble-Act Spool Spring Center & Free Flow for motors	-----	20LS-10-F4	283.99
With Dble-Act Spool, 4-way with Pressure Detent	20-10-K04-2000	413.00	-----

MID-INLET CONVERSION SECTION

With Top Inlet and Split Flow	20-12-SF	245.52	-----
With Top Inlet and Combined Flow	20-12-CF	126.02	-----

OUTLET SECTION RIGHT SIDE

Cover Plate w/Convers. Plug & End Outlet	20-RC-12-E-MY	121.30	20-RC-12-E-LS	198.97
--	---------------	--------	---------------	--------

SHUTTLE VALVE

For Load Sense Line - 6SAE Ports	-----	LSV1-6T-N	47.17
----------------------------------	-------	------	-----------	-------

THROUGH BOLT KITS COVER PLATES DO NOT COUNT AS SPOOLS

For 1 Spool Valves (NOTE: Bolts Priced Per Set)	K-20-1	1.57	K-20LS-1	1.62
For 2 Spool Valves	K-20-2	2.23	K-20LS-2	2.30
For 3 Spool Valves (NOTE: Includes Seals)	K-20-3	2.74	K-20LS-3	2.83
For 4 Spool Valves	K-20-4	2.97	K-20LS-4	3.09
For 5 Spool Valves	K-20-5	11.67	K-20LS-5	11.81
For 6 Spool Valves	K-20-6	22.16	K-20LS-6	22.33
For 7 Spool Valves	K-20-7	22.26	K-20LS-7	22.45
For 8 Spool Valves	K-20-8	22.43	K-20LS-8	22.64

ACCESSORIES

Single Lever Actuator for 2 Functions	MJ2-20L	262.27	MJ2-20L	262.27
Order 1 for each spool	K-20-VH-B	38.66	K-20-VH-B	38.66
Seal Kits-Order 1 ea. spool w/sect. seals	K-6027A	2.30		
Closed Center Plug	K-20-C	26.66		
No Relief Plug	K-20-NR	37.32		
Conversion Plug	K-20-X	15.07		
Cylinder Port Relief & Anti-Cavitation	CRA-2550	108.77		
Cylinder Port Relief & Anti-Cavitation	CRA-2000	108.77		
Power Beyond Sleeve	K-20-50-Y	46.22		
3-Position Detent Kit	K-20-D	59.99		
Spring Return Kit	K-6125	29.14		
Main Relief Cartridge	WH-1700	79.98		
Main Relief Cartridge	WH-1950	83.40		
Main Relief Cartridge	WH-2550	114.64		
Work Port Relief Adjustable 1250-1749 PSI	RC-1700	77.58		
Work Port Relief Adjustable 1750-1999 PSI	RC-1950	131.23		
Adjustable Main Relief	RP-51A-3000	151.16		

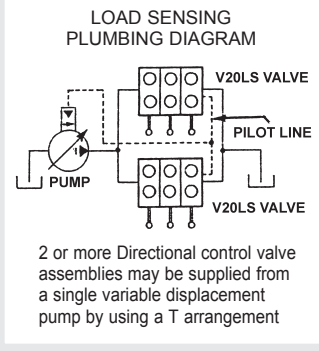

* This section is a series section, for open center systems ONLY.

Prices subject to change without notice. **ASK FOR QUANTITY DISCOUNT**

1-800-228-9222 / e-mail: sales@baumhydraulics.com
 Fax: 1-800-832-2522 / www.baumhydraulics.com / © Baum Hydraulics Corporation

BAUM HYDRAULICS CORPORATION

PARKER SECTIONAL DIRECTIONAL CONTROL VALVES

Parker/Commercial - Sectional Directional Control Valves
SOLD IN INDIVIDUAL SECTIONS, BOLT & HANDLES SOLD SEPARATELY
ORDER RELIEF VALVE SEPARATELY

SPECIFICATIONS: Valves have SEPARATE TRANSITION CHECKS built into each spool for positive control. Positive cylinder movement is maintained. Valves not exactly as pictured.

MEDIUM SIZE - DVA20 VALVES

- 30 Gallon Capacity / 2500 PSI
- 1-5/16" O-Ring B Top Inlet Port
- And 1-5/16" O-Ring End Inlet Port
- 1-5/16" O-Ring Top Outlet Port
- 1-1/16" O-Ring Cylinder Port
- 1-5/16" O-Ring End Power Beyond Port

LARGE SIZES - DVA35 VALVE

- 50 Gallon Capacity / 2500 PSI
- 1-5/16" O-Ring B Top Inlet Port
- And 1-5/8" O-Ring B End Inlet Port
- 1-5/8" O-Ring Outlet Port
- 1-5/16" Cylinder Port
- 1-5/8" O-Ring End Power Beyond Port

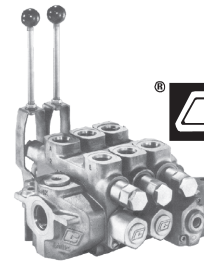

	30 GALLON VALVE		50 GALLON VALVE	
	Part No.	Price Per Piece	Part No.	Price Per Piece
INLET COVER LEFT SIDE WITHOUT RELIEF VALVE Must order Relief Valve Cartridge				
Cover Plate with end and top inlet - NO outlet	DVA20-A880	\$258.28	DVA35-A980	\$369.87
CENTER SECTION - LO-BOY				
With Double-Acting Spool 4-way	DVA20-DA7	473.27	DVA35-DA8	736.14
With Single-Acting Spool 3-way	DVA20-SA7	477.40	DVA35-SA8	693.05
With Double-Acting Spool & Float 4-way	DVA20-FC7	736.14		
With Double-Acting Spool, Detents & Free Wheeling for Motors	DVA20-MB7	467.67		
With Double-Acting Spool, Spring Return Free Wheeling for Motors			DVA35-MA8	723.57
With Double Acting Spool, 4-way, 12 Volt			DVA35-DK8*	1726.25
With Double Acting Spool, 4-way, Airshift	DVA20-DV7	813.51	DVA35-DV8	844.95
CENTER SECTION - HI-BOY				
With Double Acting Spool, 4-way	DVA20-HA755	578.52	DVA35-HA855	666.09
With Single Acting Spool, 3-way	DVA20-JA705	424.40	DVA35-JA805	600.53
With Double Acting Spool & Float, 4-way			DVA35-GC855	842.05
With Double-Acting Spool, Spring Return & Free Wheeling for Motors	DVA20-LA755	471.35	DVA35-LA855	678.31
With Double Acting Spool, 4-way, 12 Volt	DVA20-HK755*	1549.41	DVA35-HK855*	1782.03
With Double Acting Spool, 4-way, Airshift	DVA20-HV755	837.99	DVA35-HV855	926.67
MID-INLET CONVERSION SECTIONS				
With Top Inlet, Comb. Flow	DVA20-CFA70	292.17	DVA35-CFA80	375.33
With Top Inlet, Split Flow	DVA20-SFA70	292.17	DVA35-SFA80	375.33
OUTLET COVER RIGHT SIDE				
Cover plate for Power Beyond or Closed Center	DVA20-PB80	224.24	DVA35-PB90	267.52
Cover plate with end & top outlet for Open Center ONLY	DVA20-TR88	156.78	DVA35-TR99	260.34
HANDLE ASSEMBLY				
Order 1 for each spool	DV20-H-6	63.82	DV35-H-6	63.94
For DVA Section 10"	DV20-H-10	65.43	DV35-H-10	79.00
THROUGH BOLT KITS COVER PLATES DO NOT COUNT AS SPOOLS TORQUE TO 20 FOOT LBS.—NO MORE				
For 1 Spool Valves (NOTE: Bolts	DVA20-SK-1	23.21	DVA35-SK-1	43.09
For 2 Spool Valves (NOTE: Includes Seals)	DVA20-SK-2	27.91	DVA35-SK-2	54.22
For 3 Spool Valves (NOTE: Includes Seals)	DVA20-SK-3	35.20	DVA35-SK-3	76.61
For 4 Spool Valves	DVA20-SK-4	63.11	DVA35-SK-4	86.22
For 5 Spool Valves	DVA20-SK-5	69.67	DVA35-SK-5	114.86
For 6 Spool Valves	DVA20-SK-6	67.32	DVA35-SK-6	113.96
For 7 Spool Valves	DVA20-SK-7	77.74	DVA35-SK-7	124.20
For 8 Spool Valves	DVA20-SK-8	95.51	DVA35-SK-8	289.75
ACCESSORIES				
Slug Adj. 1000 PSI Relief without A/C 500-1000 PSI	DV-PRV-1	151.47	DV-PRV-1	151.47
Slug Adj. 2000 PSI Relief without A/C 1000-2500 PSI	DV-PRV-2	136.89	DV-PRV-2	136.89
2500 PSI Comb. Relief with Anti-Cavitation 500-5000	DV-PRVAC	220.43	DV-PRVAC	220.43
Work Port Relief Plug for Hi-Boy Valves	DV-PRVP	45.81	DV-PRVP	45.81
Seal kits - Sectional seals only	DV20-K-1	21.55	DV35-K-11	21.55
Seal kits - Order 1 each spool with sectional seals	DV20-K-2	55.66	DV35-K-12	54.68
Seal kit for DVA Port Relief Valve without A/C	DV20-K-3	22.61	DV35-K-3	22.61
Seal kit for DVA Port Relief Valve with A/C	DV20-K-3-1	50.63	DV35-K-3-1	50.64
Seal kit for DVA20 & DVA35 Air Shift	DV-K-7	33.49	DV-K-7	33.49
Relief Plug required for Closed Center Valves	DVA20-MRVP	50.33	DVA35-MRVP	56.39
Adj. Main Relief Cart. for Power Beyond & Open Center Valves	DVA20-MRV	191.38	DVA35-MRV-2	231.62
Detent kit 3-Position	DV20-K-101	84.58	DV35-K-201	105.93
Spring Return	DV20-K-100	55.82	DV35-K-200	65.34
Rotary Control Actuators	DV20-K-102	296.65	DV35-K-202	319.73
Airshift Actuators	DV20-K-113	434.12	DV35-K-213	291.65
Solenoid Actuators 12 Volt DC	DV20-K-106*	974.44	DV35-K-206*	974.44

* SOLENOID SECTION and INLET NEED PILOT SUPPLY MACHINING.

ASK FOR QUANTITY DISCOUNT Prices subject to change without notice.

SOLENOID CARTRIDGE & CONTROL VALVES

H9

Baum - Solenoid Cartridge Valves - **MUST ORDER CARTRIDGE, COIL & BODY**

SPECIFICATIONS: Utility On/Off Valves normally open or closed. Does not have wiring nor switches. 40 PSI Minimum to Lift Poppet.

PART NO.	TYPE	GPM	DESCRIPTION	PRICE PER PIECE
DSL101NR	Cartridge	18	Normally Open Cartridge for 10 series CAP **** Coil	\$74.58
DSL101CR	Cartridge	18	Normally Closed Cartridge for 10 series CAP **** Coil	55.60
DSH161NR	Cartridge	50	Normally Open Cartridge for 16 series CAP **** Coil	131.53
DSH161CR	Cartridge	50	Normally Closed Cartridge for 16 series CAP **** Coil	117.97
CAP012S	Coil		12 Volt Spade connector coil 0.64" ID x 1.97" Long	35.93
CAP115C	Coil		110 Volt dbl. lead wire w/ conduit connector 0.64" ID x 1.97" Long	58.99
CCP012S	Coil		12 Volt Spade connector coil 0.52" ID x 1.57" Long	30.51
CCP115C	Coil		115 Volt dbl. lead wire w/ conduit connector 0.52" ID x 1.57" Long	53.56
B10-2-8T	Body		Cartridge Valve Body for 10 series 80RB ports 3/4-10 Thread	51.53
LB10573A	Body		Cartridge Valve Body for 16 series 160RB ports 1-5/16-12 Thread



Solenoid Control Valves

PRODUCT FEATURES: 4-way 12 volt solenoid valve section, multiple valves can be used by ordering the correct mounting bracket.

MD06 Control Valve 12 Gallon

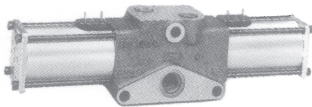

MS06 Selector 12 Gallon

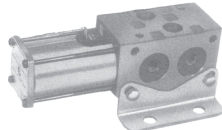

Part Number	Description	Price Per Piece
MD06-SDNC-AD-12B	4-way Single 12 volt with 3/4 o-ring ports	\$1054.40
MOUNTING BRACKETS FOR ABOVE VALVE:		
K-707871	For Single Valve Kit	69.48
K-707872	For Two Valve Kit	71.28
K-707873	For Three Valve Kit	83.02
K-707874	For Four Valve Kit	100.16
K-707875	For Five Valve Kit	107.38
MS06-UDNA-12B	Double Selector 12 volt with 9/16 o-ring ports	537.47
493419	12 Volt coil for MD & MS	117.30

Solenoid Control Valves

PRODUCT FEATURES:

- No back pressure - 12 Volt
- Direct Solonoid Operator
- Maximum Operation PSI 3600
- 3 Position 4-way valves with neutral valves comes with bolt kit and o-rings but not subplate.

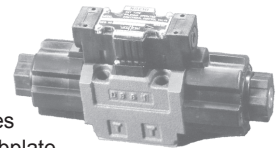

Part Number	GPM / Description	Price Per Piece
FREE WHEELING FOR MOTORS		
SSG03-C4-R-C115-E20	20	\$469.29
SSG03-C4-R-D1-E 20	20	440.92
CLOSED CENTER		
SSG03-C5-R-D1-E 10	20	488.93
TANDEM VALVE (Open Center - Cylinder Ports Blocked)		
SSG03-C7Y-R-D1-E 10	13	427.92
SSG03-C7Y-R-D1-E 22	20	427.92
SUBPLATE SIDE PORTS - 3500 PSI - ALUMINUM		
A-D03-SPS-6S	9/16-18 Side Ports SS-G01	\$72.20
A-D05-SPS-8S	3/4-16 Side Ports SS-G03	110.11

Fasse - Utility On/Off Control Kit

FEATURES:

- Up to 18 GPM
- 1820 normally closed flow path is opened when coil is energized
- 1821 normally open flow path is blocked when coil is energized
- Available in 40 GPM model, 700-1840 N/C or 700-1841 N/O
- Valve mounts on tractor or implement
- Easy installation
- 3000 PSI rated

OPTIONS:

- 12 volt positive ground coils
- 24 volt negative ground coils

NOTE: 700-1840 and 700-1841 have 1-1/16 o-ring thread

STANDARD 700-1820 KIT (SHOWN)

- On/off normally closed control valve
- Toggle switch box with mounting bracket
- 12' wiring harness, 6' power wires
- 3/4" o-ring fittings
- 12 volt negative ground coils
- Fuse kit, connectors, wire ties
- Installation and operation guide

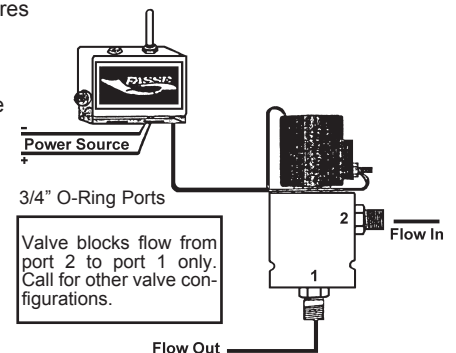

Description	Part Number	Price Per Piece
Remote Normally Closed On/Off Series	700-1820	\$313.14
Remote Normally Open On/Off Series	700-1821	\$346.35
Remote Normally Closed On/Off Series	700-1840	\$366.91
Remote Normally Open On/Off Series	700-1841	\$347.03

Prices subject to change without notice. **ASK FOR QUANTITY DISCOUNT**

1-800-228-9222 / e-mail: sales@baumhydraulics.com
 Fax: 1-800-832-2522 / www.baumhydraulics.com / © Baum Hydraulics Corporation





Fasse Valves - 2 Circuit Selector

2 SPOOL VALVE WITH SWITCH - 3/4-16 O-Ring Ports

Price Per Piece:
\$877.75

Part Number:
700-1510

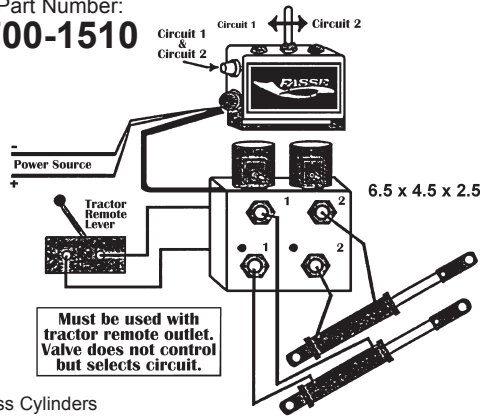

Less Cylinders

STANDARD 700-1510 KIT (SHOWN)

- Two Circuit Selector Valve
- Toggle Switch box with mounting bracket
- 12' wiring harness, 6' power wires
- Fasse eccentric fittings
- Fasse ISO quick couplers and tips

TYPICAL APPLICATIONS				
Loader	Marker Arms	Bat Wing Mowers	Round Balers	Box Scrapers
Bucket	Left	Right Wing	End Gate	Height
Grapple	Right	Left Wing	Bale Tie	Angle

- Colored dust plugs and caps
- 12 volt negative ground coils
- Fuse kit, connectors, wire ties
- Installation and operation guide

SPOOL SELECTOR VALVE KIT REMOTE MASTER SERIES 700-1510

FEATURES:

- Up to 20 GPM
- Operate multiple functions from one remote outlet
- Keep high pressure hydraulic lines & cables out of the cab
- Double or single acting cylinder operation
- Valve plugs directly into existing remote or may be mounted on implement

- Both circuits can be selected at the same time, lightest load moves first
- Universal, use on Open, Closed or PFC hydraulic systems
- Up to 6 circuit control available
- Easy installation
- 3000 PSI rated



Fasse Valves - 3 Circuit Selector

3 SPOOL VALVE WITH JOYSTICK - 3/4-16 O-Ring Ports

Price Per Piece:
\$1543.20

Part Number:
700-1553

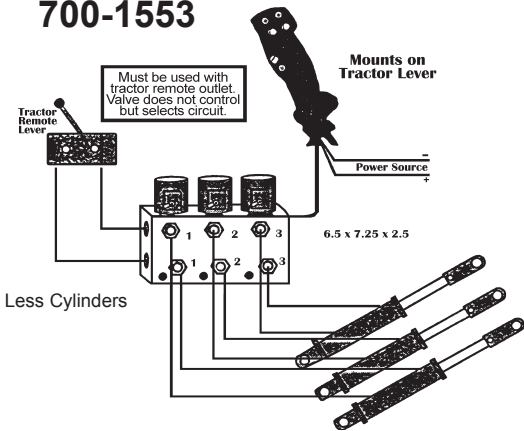

Less Cylinders

STANDARD 700-1553 KIT (SHOWN)

- Three Circuit Selector Valve
- Remote command stick control
- 12' wiring harness, 6' power wires
- Fasse ISO quick couplers and tips
- Colored dust plugs and caps
- 12 volt negative ground coils
- Fuse kit, connectors, wire ties
- Installation and operation guide

TYPICAL APPLICATIONS				
Loader	Planter	Tool Bar	Bat Wing Mowers	Blade
Boom	Left Marker	Left Wing Fold	Right Wing	Tilt
Bucket	Lift Assist	Lift Assist	Raise/Lower	Angle
Grapple	Right Marker	Right Wing Fold	Left Wing	Raise/Lower

OPTIONS FOR STANDARD KIT:

- 12 volt positive ground coils
- 24 volt negative ground coils
- John Deere or IH couplers

SPOOL SELECTOR VALVE KIT REMOTE MASTER SERIES 700-1553

FEATURES:

- Up to 20 GPM
- Double or single acting cylinder operation
- Operate multiple functions from one remote outlet
- Universal, use on Open, Closed or PFC hydraulic systems

- Valve mounts on tractor or implement
- Allows tractor float operation on selected circuits
- Easy installation
- 3000 PSI rated



Optional Remote Command Stick

JOYSTICK FOR 2 or 3 SPOOL VALVE

Works with either 2 or 3 Circuit Selector

Price Per Piece:
\$476.55

Part Number:
300-081

ASK FOR QUANTITY DISCOUNT Prices subject to change without notice.

HAYDEN HYDRAULIC OIL COOLERS

H11



Hayden makes a wide variety of sizes and types of oil-to-air coolers. Regardless of the application - stationary or vehicular - there's a Hayden unit designed to deliver reliable cooling power. Hayden heat transfer capability is widely used as auxiliary cooling on existing equipment, as complete cooling replacements or as original equipment at the OEM stage. Any system that generates hot oils or viscous fluids needs Hayden "Cooling Power".

20 degrees of cooling **doubles life** of petroleum oils. Conversely, - HEAT KILLS OIL - by more rapidly forming oxides, waxes, varnishes, and sludges. Heat volatilizes additives. Heat reduces viscosity, causing bearing failures.

Bypass line may be added, provides temporary increased capacity and cold weather protection. Use C-1200S-65 check valve.

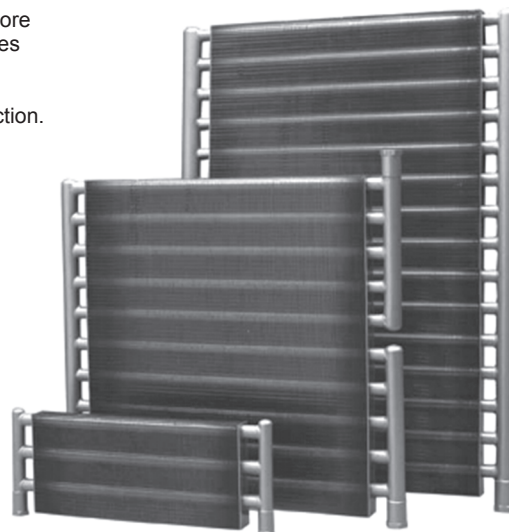

Standard Capacity Ratings Transcoolers

Model Number	Price Per Piece	Cooling Cap. BTU/Hr.	Max. GPM	Outside Dimensions, Inches			Fitting Size FPT	Unit Wt. Lbs.
				Height	Length	Width		
1215	\$84.06	7,110	8	4	15	1-1/2	1/2	9
1240	115.39	13,300	12	6	18	1-1/2	1/2	12
1241	144.29	21,300	16	8	21	1-1/2	1/2	14
1268	183.60	25,800	24	12	18	1-1/2	3/4	17
1260	216.76	35,200	24	12	24	1-1/2	3/4	15
1290	285.05	54,300	36	18	24	1-1/2	3/4	27
1292	396.80	72,300	48	24	24	1-1/2	1	23
2305	469.97	90,400	60	30	24	1-1/2	1	34

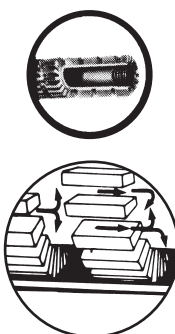
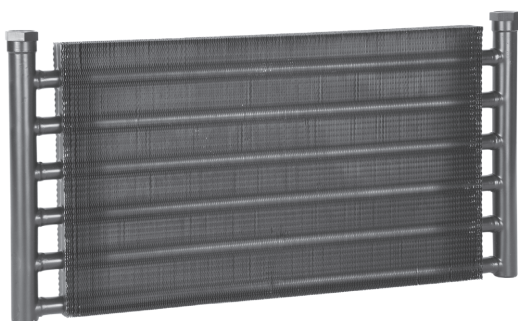

Inner-Swirl Action is created by uniquely designed inner-swirl fins located inside the cooler tubes.

As the hot oil flows through the swirl fins, hundreds of tiny "swirlpools" swirl clockwise and then counter-clockwise at precisely tooled spiral-grooved openings. This 360° swirling action assures double heat extraction by the double turn exposure of hot oil to the cold air side of the cooler.

In cold weather environments, you need to add the following Check Valve Part Number: C-1200S-65



Oil Supply Tanks

As a general recommendation you should not have a tank smaller than the GPM rating on your pump. For example: a ten gallon tank could take up to a 10 GPM pump. This would mean the oil would be completely changed each minute. The longer time the oil has to spend in the tank the more chance entrained air has of separating out and contamination particles have of setting.

Ideally the tank should be above the pump and as close as possible to the pump to cut down on line resistance to flow.

Part Number	Gallon Capacity	Tank Size Width x Height x Depth	Price Per Piece
SMR15S	15	19.58 x 17.5 x 14.5	\$346.68
SMR25S	25	22.35 x 20.0 x 16.0	369.93
SMR30S	30	28.35 x 22.0 x 17.0	459.89
		Add 2.1 to height for fill cap	

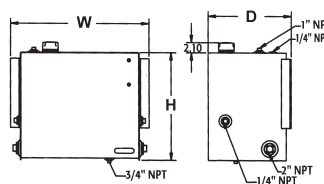

Chrome filler breather with basket strainer. Oil level gauge with temperature indicator. Interior baffle between suction and discharge. Large 2" NPT suction ports. Magnetic drain plug. Factory powder coated.

LDR02A 5" Sight Gauge w/Thermometer \$ 38.71

Prices subject to change without notice. **ASK FOR QUANTITY DISCOUNT**

1-800-228-9222 / e-mail: sales@baumhydraulics.com
 Fax: 1-800-832-2522 / www.baumhydraulics.com / © Baum Hydraulics Corporation

BAUM HYDRAULICS CORPORATION

INLINE CHECK VALVES

To allow free-flow in one direction and blocked flow in the reverse direction.
Check Valves may also be used to provide 5 pounds, or 65 pounds of back pressure in full flow direction to assist pilot-operated solenoid valves.

Manatrol - Inline Check Valves

SPECIFICATIONS: Max. Pressure 3,000 PSI, 1/8 to 1/2 have soft seats, 3/4 and larger have steel seats



Pipe Thread Size	Part Number	Max. Flow GPM	Price Per Piece	Pipe Thread Size	Part Number	Max. Flow GPM	Price Per Piece
5 PSI - CRACKING PRESSURE				65 PSI - CRACKING PRESSURE			
1/4	C-400-S	5	\$33.16	1/2	C-800S-65	15	\$38.85
3/8	C-600-S	8	39.25	3/4	C-1200S-65	25	67.68
1/2	C-800-S	15	44.79	1	C-1600S-65	40	263.30
3/4	C-1200-S	25	67.70	1-1/4	C-2000S-65	70	244.31
1	C-1600-S	40	124.52				

BALL VALVES FOR HYDRAULIC USE

Two Piece Design Ball Valve with Pipe Threaded Ends and Removable Handle



Pipe Thread Size Ins.	Ball Valve Number	Price Per Piece
GRINNEL - 600 PSI - CAST BRASS		
1/4	171N	\$35.85
3/8	171N	35.85
1/2	171N	39.82
3/4	171N	57.83
1	171N	79.13
1-1/4	171N	135.55
1-1/2	171N	104.64
2	171N	190.19



Pipe Thread Size Ins.	Ball Valve Number	Price Per Piece
PARKER - 2000 PSI - CARBON STEEL		
1/4	V500CS4	\$35.19
3/8	V500CS6	36.87
1/2	V500CS8	41.20
3/4	V500CS12	54.14
1	V500CS16	69.71

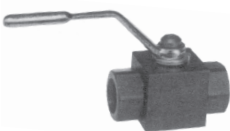

PARKER - 6000 PSI - STEEL			
3/8	BVHP06NSS1N	\$77.52	
1/2	BVHP08NSS1N	84.59	



Port Size	Model Number	Max PSI	Price Per Piece
WOLVERINE - 2 WAY HIGH PRESSURE BALL VALVES			
1/4 NPTF	WBV2-400	7,250 PSI	\$23.90
3/8 NPTF	WBV2-600	7,250 PSI	27.21
1/2 NPTF	WBV2-800	7,250 PSI	33.21
3/4 NPTF	WBV2-12	4,500 PSI	54.31
1 NPTF	WBV2-1600	4,500 PSI	69.61

HYDRAULIC CUSHION VALVE

USE-To eliminate or minimize shock experienced in starting and stopping hydraulic motors, and other hydraulic equipment.

When a standard control valve is returned to neutral to stop or to start a motor, or other heavy hydraulic equipment, this creates sudden excess pressure which will break seals, tear off motor shafts, burst motor cases, or burst hoses. This sudden shock cannot be relieved through the primary relief valve in the system, and a cushion valve must be installed in the two lines from control valve to motor or cylinders.

When the motor can free-wheel to a stop, a Motor Spool control valve and no cushion valve is used. When motor must hold load in position when stopped, as on a winch, a Standard 4 way control valve and a cushion valve are used.

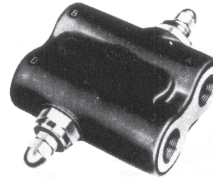

Cross
Differential Poppet Type
Double Relief



Gresen
Ball/Spring Type Dual
Crossover Relief

Port Size	Part Number	Maximum GPM	Setting	Price Per Piece
-----------	-------------	-------------	---------	-----------------

CROSS - Set at 2000 PSI, Maximum 3000 PSI				
3/4	RC1200DD	30	---	\$150.40

GRESEN -				
3/8	DXV-38-2000	16	2000	\$165.78
1/2	DXV-50-1800	20	1800	165.78
1/2	DXV-50-2000	20	2000	254.60
3/4	DXV-75-2000	30	2000	158.36

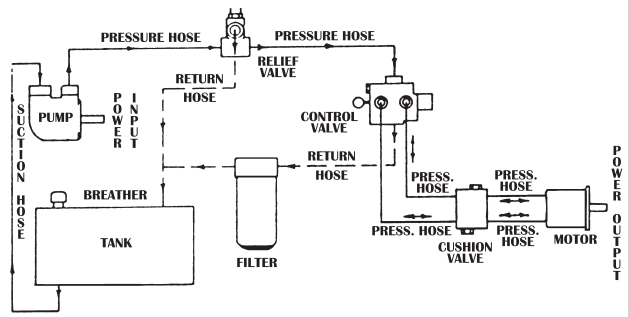

ASK FOR QUANTITY DISCOUNT Prices subject to change without notice.

MIX AND MATCH RELIEF VALVE CARTRIDGES & HOUSINGS

Select the housing you need. Then pick a relief cartridge of the SAME BRAND.
DO NOT MIX BRANDS. These may be substituted for standard reliefs of the same size.

GRESEN EMPTY RELIEF HOUSINGS

Must Add Relief Cartridge

Port Size	Part Number	Style	Price Per Piece
1/2	K-WJL-50	Inline	\$159.71
3/4	K-WJL-75	Inline	142.57
3/4	K-RPL-75	Inline	237.32
1	K-RPL-100	Inline	271.60



K-WJL

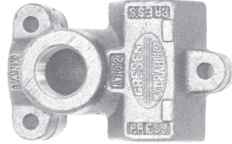

K-RPL

All properly designed hydraulic systems **MUST** contain a main system relief valve. Whether simple or complex, hydraulic systems are too expensive to run without a relief valve. REMEMBER THE RELIEF.

GRESEN RELIEF CARTRIDGES

Cartridge Only, No Housing



Part Number	Std. Setting PSI	Adjusted Pressure Range PSI	GPM Rating	Fits Housing	Price Per Piece
DIFFERENTIAL POPPET RELIEF - ADJUSTABLE WITH SHIMS					
K-WH-A	Converts WH Series to Screw Adjustable				\$32.77
WH-500	500	500-1350	20	K-WJL	79.98
WH-1000	1000	1000-1550	20	K-WJL	83.40
WH-1200	1200	500-1350	20	K-WJL	79.98
WH-1700	1750	1351-1750	20	K-WJL	79.98
WH-1950	2200	2001-2600	20	K-WJL	83.40
WH-2550	2500	2001-2600	20	K-WJL	114.64
WH-3000	3000	2500-3000	20	K-WJL	79.98

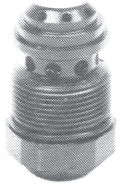

WH

BALL & SPRING RELIEF - SCREW ADJUSTABLE

KC-HP-2000	2000	1401-2500	20	K-RPL	242.34
-------------------	------	-----------	----	-------	---------------

PILOT RELIEF - SCREW ADJUSTABLE

RP-60A-2500	2500	500-3500	60	K-RPL	450.43
--------------------	------	----------	----	-------	---------------

PARTS FOR HYDRAULIC RELIEF VALVES

Seal Kit for WH Valves

K-19003	For Valve No.:	WH Relief Seal Kit	0.65
----------------	----------------	--------------------	-------------



RP60A
KC-HP

Pilot Operated Relief

USE - For large capacity hydraulic systems to maintain close control over the maximum operating pressure.

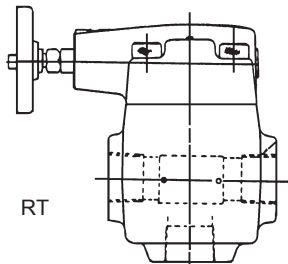

RT

**INLINE STYLE - RT- BAUM
ARE KNOB ADJUSTABLE TYPE**

Pressure Set at: 1500 PSI
Adjustable Pressure Range: 500-3000 PSI

Port Size	Part Number	Brand	Relief Port Cap GPM	Price Per Piece
3/4 NPT	RT-06-3-E20	Baum	60	\$334.41
1-1/4 NPT	RT-10-3-E20	Baum	120	481.69

All properly designed hydraulic systems **MUST** contain a main system relief valve. Whether simple or complex, hydraulic systems are too expensive to run without a relief valve. REMEMBER THE RELIEF.

CUSHION VALVE CARTRIDGES and HOUSINGS

Select the housing you need. Then pick two (2) relief cartridge of the SAME BRAND. DO NOT MIX BRANDS.

GRESEN EMPTY CUSHION VALVE HOUSINGS

Must Add (2) Relief Cartridges

Port Size	Part Number	Max. GPM Flow	Price Per Piece
1/2	K-DWV-50	20	\$163.32
3/4	K-DWV-75	30	163.32

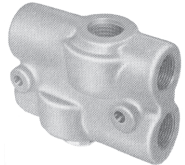

RP-51A CANNOT be used in the DWV Cushion Valve.

GRESEN CARTRIDGES for CUSHION VALVES

Cartridge Only, No Housing

Port Size	Part Number	Use Housing	Price Per Piece
1/2	WH Series	order (2) cartridges above	\$79.98
3/4	WH Series	order (2) cartridges above	79.98

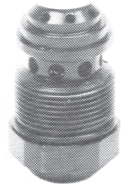

WH

TO MAKE CUSHION VALVES USING CARTRIDGES

Port Size	Part Number	Use Relief Cartridges	Use Housing	PSI
1/2	DWV-50-A-2000	(2) WH-2000	K-DWV-50	2000
1/2	DWV-50-A-2500	(2) WH-2500	K-DWV-50	2500
3/4	DWV-75-A-2000	(2) WH-2000	K-DWV-75	2000
3/4	DWV-75-A-2500	(2) WH-2500	K-DWV-75	2500

NOTE: Gresen does not recommend pressures in excess of 2000 PSI with pipe thread.

Prices subject to change without notice. **ASK FOR QUANTITY DISCOUNT**

1-800-228-9222 / e-mail: sales@baumhydraulics.com

Fax: 1-800-832-2522 / www.baumhydraulics.com / © Baum Hydraulics Corporation

BAUM HYDRAULICS CORPORATION

H14

COMPLETE HYDRAULIC RELIEF VALVES

A relief valve must be installed in the hydraulic system with each one of these pumps to prevent exploding the pump, damaging the equipment, or bursting the hose.

For the correct working position for the various parts of a hydraulic system, see the diagrams on this page.

Ball and Spring Type

USE - For fast-acting and occasional relief.

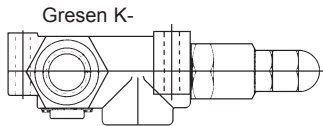
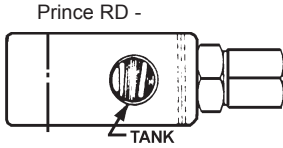

Commercial DVLR-

INLINE STYLE - ALL ARE SCREW ADJUSTABLE TYPE

Port Size	Part Number	Brand	Relief Port Cap GPM	Pressure Set at PSI	Adjustable Pressure Range PSI	Price Per Piece
1/2	RD1850H	Prince	20	1500	1000-2500	\$72.81
3/4	RD1875H	Prince	24	1500	1000-2500	72.81
3/4	WJL-75-A-2000	Gresen	24	2000	1201-2500	171.96
3/4	WJL-75-A-1250	Gresen	30	1200	1250-1749	164.76
3/4	K-75-HP	Gresen	38	1500	1401-2000	566.86
1	K-100-HP	Gresen	38	1500	1401-2000	607.39
1 NPT	DVLR-64	Commercial	60	2000	2000-2500	438.42

Differential Poppet Type

USE - Where you need a continuous acting relief.

These are quiet and smooth acting.

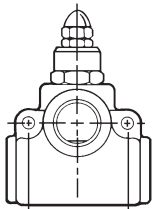

Cross RD-

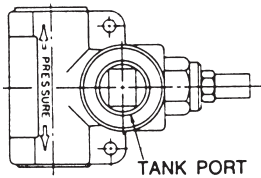

Prince RV -

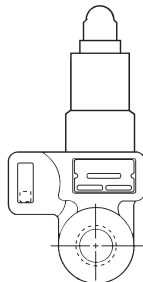

Gresen WJL-

INLINE STYLE - SCREW ADJUSTABLE TYPE

Port Size	Part Number	Brand	Relief Port Cap GPM	Pressure Set at PSI	Adjustable Pressure Range PSI	Price Per Piece
1/2	RV-4H	Prince	20	2000	1500-3000	\$77.06
1/2	WJL-50-A-1250	Gresen	20	1250	1250-1749	158.36
1/2	WJL-50-A-2200	Gresen	20	2000	2000-2599	158.36
3/4	RD12B	Cross	30	1000	500-1500	76.75
3/4	RD12D	Cross	30	2000	1500-3000	76.75
3/4	WJL-75-A-1250	Gresen	25	1250	1250-1749	164.76
3/4	RV-2H	Prince	30	2000	1500-3000	72.71
3/4	WJL-75-A-2200	Gresen	25	2000	2000-2599	171.96

SAND SPREADER VALVE

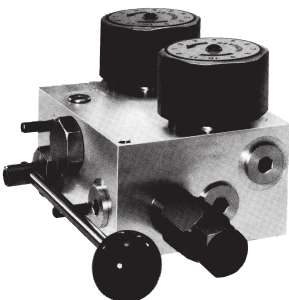

MANUAL ON - OFF

Dual Flow Regulator Valve with on-off and Relief.
Working Pressure 2000 PSI Set at 1500 PSI
SAE O-Ring Boss Ports

Part Number	Auger Port	Spreader Port	Price Per Piece
QDB-12-A07B16AR	7	16	\$....
QDB-12-A10B30AR	10	30	667.51

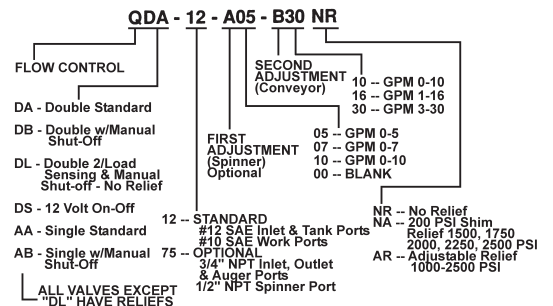

ASK FOR QUANTITY DISCOUNT

Prices subject to change without notice.

BAUM HYDRAULICS CORPORATION

1-800-228-9222 / e-mail: sales@baumhydraulics.com
Fax: 1-800-832-2522 / www.baumhydraulics.com / © Baum Hydraulics Corporation

FLOW CONTROL VALVES

H15

USE - To Control Speed of Motors & Cylinders Excess Flow Can Be Used
This valve will start and stop a hydraulic motor or cylinder and vary the speed smoothly over the full range. Once the speed is set with the lever it will remain constant regardless of load variation.

PRINCE FLOW CONTROL VALVE WITH NO RELIEF

Max. 3000 PSI - Lever Adjustment - Wt. 7 Lbs.

Port Size	Part Number	Max Adj. Flow GPM	Price Per Piece
3/8	RD137-8	8	\$132.29
1/2	RD150-16	16	143.14
3/4	RD175-30	30	146.15

PRINCE FLOW CONTROL VALVE WITH ADJUSTABLE RELIEF

Max. 3000 PSI - Lever Adjustment - Wt. 8 Lbs.
Set @ 1500 PSI in controlled flow.

Port Size	Part Number	Max Adj. Flow GPM	Price Per Piece
1/2	RDRS150-16	16	\$151.32
3/4	RDRS175-30	30	154.31

Prince

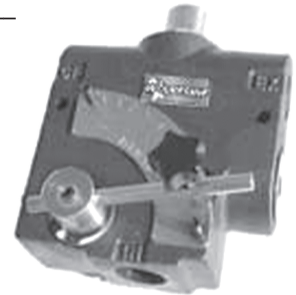

WOLVERINE ADJUSTABLE FLOW CONTROL VALVES

Part Number	Description	Cross Reference	Price Per Piece
W-1950-16	1/2 NPTF Ports (O-16 GPM No Relief)	FC51-1/2	\$96.71
W-1975-30	3/4 NPTF Ports (O-30 GPM No Relief)	FC51-3/4	\$92.05
WR-1950-16	1/2 NPTF Ports (O-16 GPM W/Relief)	FCR51-1/2	\$99.81
WR-1975-30	3/4 NPTF Ports (O-30 GPM W/Relief)	FCR51-3/4	\$99.81



FLOW DIVIDERS

FLOW DIVIDER-COMBINER - Max. 2500 PSI
These valves not only divide flow, but also combine flow in reverse direction.

Port Size	Part Number	Flow Range	Price Per Piece
1/2	PDC-50-50	5-25	\$263.13
3/4	PDC-75-50	15-35	263.13



GRESEN FLOW DIVIDER - COMBINER

1/2	PDC-50-50	5-25	\$263.13
3/4	PDC-75-50	15-35	263.13

PRINCE FLOW DIVIDER - COMBINER

1/2	RD1550.062	2-3	\$271.38
1/2	RD1550.078	3-8	266.00
1/2	RD1550.140	8-16	271.38
3/4	RD1575.187	12-20	266.00

Prince

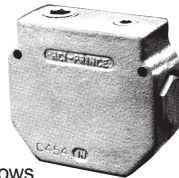

FLOW DIVIDER- PROPORTIONAL

Operates in One Direction ONLY.
USE - Flow divider must be between pump & control valve. To divide a single flow of all into TWO EQUAL FLOWS, even through work being done by one of the flows is greater than the other. A filter must be used with this flow divider. Cross drilled shifting type spool provides very accurate metering. 3 mounting holes. Max. pressure 2500 PSI

Port Size	Part Number	Flow Range	Price Per Piece
1/2	PD-50-50	5-25	\$215.95
3/4	PD-75-50	15-35	215.95

GRESEN FLOW DIVIDER - PROPORTIONAL

1/2	PD-50-50	5-25	\$215.95
3/4	PD-75-50	15-35	215.95

PRINCE FLOW DIVIDER - PROPORTIONAL

1/2	RD250-16	8-16	\$121.62
3/4	RD275-30	16-30	121.62

PRINCE FLOW DIVIDER - PROPORTIONAL with Reverse Free Flow

1/2	RD350-16	8-16	\$182.14
3/4	RD375-30	16-30	168.37

GRESEN - ADJUSTABLE FLOW CONTROL DIVIDER

2500 PSI - WT. 8 LBS. - EXCESS FLOW CANNOT BE USED.
USE - To control speed of motors or cylinders in both directions. Very fine adjustment possible. Valve is pressure compensated in forward direction ONLY.

Port Size	Part Number	Flow Range	Price Per Piece
1/2	CFDA-50	0-15 GPM	\$359.52
3/4	CFDA-75	0-15 GPM	359.52



CF=Controlled flow work port EF=Excess flow to tank ONLY P=Oil from pump

PRIORITY DIVIDER - FLOW DIVIDER for POWER STEERING

USE - To divide one flow of oil into one constant volume flow and another excess volume flow regardless of pump speed or pressure. For use for power steering or other applications where two separate power circuits are to be served from one pump. A filter must be used with this flow divider.

Part Number	Constant Flow	Capacity GPM	Price Per Piece
RD450R-4	4 GPM	30 GPM	\$177.17
RD450R-6	6 GPM	30 GPM	168.58
RD450R-8	8 GPM	30 GPM	168.58

PRINCE 1/2" INLET & EXCESS 1/2" CONSTANT 3/8"

TANK PORT ADJUSTABLE RELIEF SET 1500 PSI

RD450R-4	4 GPM	30 GPM	\$177.17
RD450R-6	6 GPM	30 GPM	168.58
RD450R-8	8 GPM	30 GPM	168.58

Prince

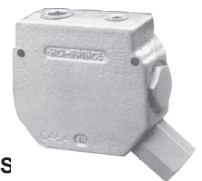

PRINCE 3/4" INLET & EXCESS 3/4" CONSTANT 1/2"

TANK PORT ADJUSTABLE RELIEF SET 1500 PS

RD405R-4	4 GPM	30 GPM	\$187.61
RD405R-6	6 GPM	30 GPM	160.41
RD405R-8	8 GPM	30 GPM	160.41

GRESEN



GRESEN FLOW DIVIDERS

Gresen 1-1/16 all ports except relief
3/4 o-ring 3500 PSI valve

DC25A-12	ADJ.	30 GPM	\$301.52
-----------------	------	--------	-----------------

Prices subject to change without notice. **ASK FOR QUANTITY DISCOUNT**

1-800-228-9222 / e-mail: sales@baumhydraulics.com

Fax: 1-800-832-2522 / www.baumhydraulics.com / © Baum Hydraulics Corporation

BAUM HYDRAULICS CORPORATION

FLOW CONTROL VALVES

Controlled flow in ONE direction. Free flow in reverse.

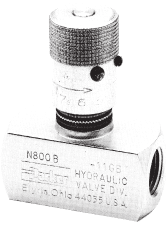

MANATROL N SERIES WITH COLOR FLOW

Made of Steel. Max. 3000 PSI

Size	Part Number	Max. Flow @ 1000 PSI	Price Per Piece
1/4	N-400-S	5	\$39.25
3/8	N-600-S	8	100.20
1/2	N-800-S	15	70.38
3/4	N-1200-S	25	79.18
1	N-1600-S	40	337.70



Pipe Thread

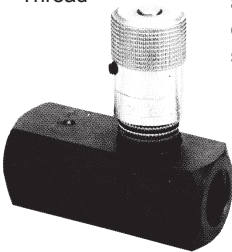

PARKER SERIES F LINE-MOUNTED FLOW CONTROL VALVES

Precisely controlled flow and shut-off in one direction, free flow in reverse. Two-step needle to give fine adjustments for low flows in the first three turns and conventional throttling in the last three turns. Has a set screw to lock valve settings.

Size	Parker Part Number	Max. Flow	Price Per Piece
1/4	F-400-S	5	\$41.96
3/8	F-600-S	8	53.46
1/2	F-800-S	15	127.52
3/4	F-1200-S	25	121.57
1	F-1600-S	40	275.44



WOLVERINE BY PRINCE FLOW CONTROL VALVES

Inline in sizes from 1/8" to 1" Flows of 4 to 40 GPM- Maximum pressure of 3,000 PSI. Patented "Colorflow" adjustment reference. Made of Steel.

Size	Precise Part Number	Max. Flow	Price Per Piece
1/4	WFC-400	5	\$36.96
3/8	WFC-600	8	41.78
1/2	WFC-800	15	51.83
3/4	WFC-1200	25	95.77
1	WFC-1600	40	232.98

NEEDLE & SHUT-OFF VALVE

Controlled Flow in BOTH Directions
USE - Throttling and shut-off valves suitable for speed control of cylinders and motors.

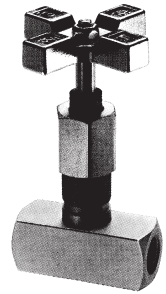

MANATROL MV SERIES WITH COLOR FLOW

Made of Steel. Max. 3000 PSI

Size	Part Number	Max. Flow @ 1000 PSI	Price Per Piece
1/4	MV-400-S	5	\$43.31
3/8	MV-600-S	8	63.61
1/2	MV-800-S	15	77.15
3/4	MV-1200-S	25	127.91
1	MV-1600-S	40	458.02



WOLVERINE BY PRINCE IN-LINE NEEDLE VALVE

Carbon Steel Body.
Designed to provide precision flow control.
Operating temp range -20°F through 210°F

Port Size	Part Number	Max. PSI	Max Flow	Price Per Piece
1/4 NPTF	WNV-400	5,000 PSI	5 GPM	\$33.00
3/8 NPTF	WNV-600	5,000 PSI	8 GPM	44.38
1/2 NPTF	WNV-800	5,000 PSI	16 GPM	55.85
3/4 NPTF	WNV-1200	3,000 PSI	25 GPM	95.36
1 NPTF	WNV-1600	3,000 PSI	40 GPM	231.57

GRESEN LINE THROTTLE VALVES NON-ADJUSTABLE FLOW - One Way Line Throttle

USE - To regulate maximum speed of cylinders in one direction. ECONOMY TYPE.
Restricts the flow in one direction, full flow in opposite direction. Will operate satisfactorily in any position. 1/2" pipe thrd. male & female outlets, 2-1/8" long. Plastic ball has drilled orifice.

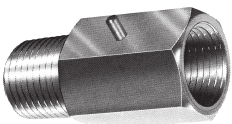

Part Number	Thread Size Inches	Plastic Ball Color	Restricted Capacity GPM at 1000 PSI	Approx. Size Orifice in Restrictor Inch	Price Per Piece
LT-50-4	1/2	Brown	1	1/32	\$95.42
LT-50-6	1/2	Purple	3	1/16	44.97
LT-50-9	1/2	Red	5	3/32	43.93
LT-50-12	1/2	Yellow	11	1/8	43.93
LT-50-15	1/2	Green	14	5/32	42.33

GRESEN LINE THROTTLE VALVES

Part Number	Thread Size Inches	Plastic Ball Color	Restricted Capacity GPM at 1000 PSI	Approx. Size Orifice in Restrictor Inch	Price Per Piece
LT-10-0	7/8	Neutral	Check	None	\$
LT-50-0	1/2	Neutral	Check	None	43.93
LT-75-00	3/4	Neutral	Check	None	84.70

GRESEN CHECK VALVES

ALSO AVAILABLE IN 3/4 O-RING THREAD

ASK FOR QUANTITY DISCOUNT Prices subject to change without notice.

HYDRAULIC SELECTOR VALVES

H17

DOUBLE SELECTOR VALVE - USE - To operate two sets of double-acting cylinders one at a time with one 4-way (double-acting) control valve. This valve is used where one double-acting cylinder is on the front and one is on the rear of the tractor, and both are operated by the same control valve. Also use this valve to add another double-acting cylinder on a tractor where you want to use the existing control valve to operate both double cylinders separately.

PRINCE - Max. Pressure 2500 PSI

Port Size	Part Number	Capacity GPM	Price Per Piece
1/2	DS-1A1E	20	\$185.33
3/4	DS-4A1E	30	185.33
Push Knob 670400029			
5/16-18 Thread			7.47

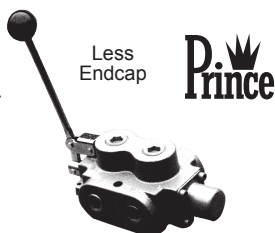

GRESEN - Max. Pressure 2500 PSI

Port Size	Part Number	Capacity GPM	Price Per Piece
3/4	DS75	24	\$418.36
O-Ring Thread Max. Pressure 3000 PSI			
1-1/16	DS12	24	225.54

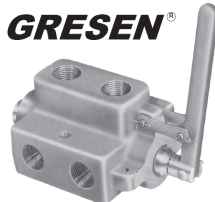

CROSS - Max. Pressure 2500 PSI *

Port Size	Part Number	Capacity GPM	Price Per Piece
1	SD4BALA6	40	\$193.32
Cross Selector Valve Linkage Kit			
1-1/16	1V1730	--	9.53



* Spool Cap not included with valve.

SINGLE SELECTOR VALVE - USE - To operate two control valves from one pump or, to operate separately two single-acting cylinders from one control valve. This hydraulic selector valve is particularly useful on tractors with a backhoe mounted on the rear and a loader, dozer or snowplow on the front. The selector valve can be mounted between the pump and two groups of control valves. This allows you to direct the flow either to the control valves for the loader in front or to the control valves for the backhoe in the rear.

PRINCE - Max. Pressure 3000 PSI

Port Size	Part Number	Capacity GPM	Price Per Piece
1/2	RD950	20	\$148.00
3/4	RD975	30	148.01

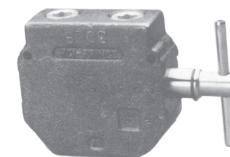

GRESEN - Max. Pressure 2000 PSI

Port Size	Part Number	Capacity GPM	Price Per Piece
1/2	S50	15	\$163.96
3/4	S75	24	147.96
1	S100	40	269.27

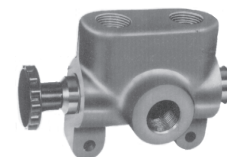

CROSS - Max. Pressure 2500 PSI

Port Size	Part Number	Capacity GPM	Price Per Piece
1/2	VS2BKLF2	20	\$86.50
3/4	VS4BKLF6	40	117.28

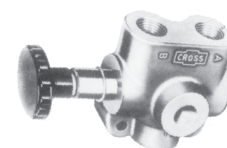

Marker Valve For Planters Sequence Valve

PRODUCT FEATURES: This is an excellent valve for operating planter markers. Both markers will raise together, but only one marker will drop. This process will alternate between markers.

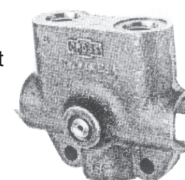

Part Number	Ports	PSI Rating	Weight	Price Per Piece
SQV	3/4 O-ring	2500	6 lbs.	\$165.09

PRESSURE LOCK VALVES ELIMINATES CYLINDER CREEP

For Use With Double-Acting 4-way Valves ONLY

USE - To lock a cylinder in position and prevent its movement due to leakage or slippage when the control valve is in neutral position.

* NOTE: 7/8 is o-ring ports

DOUBLE ACTING - To Lock in BOTH DIRECTIONS with a 4-way Valve

GRESEN 2500 PSI - DOUBLE ACTING

Port Size	GRESEN Part Number	Max GPM Flow	Price Per Piece
1/2	LO-50-D	25	\$327.92
7/8	LO-10-D	30	217.55

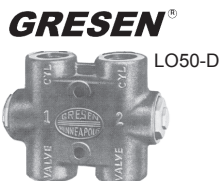

PRINCE 2500 PSI - DOUBLE ACTING

Port Size	PRINCE Part Number	Max GPM Flow	Price Per Piece
1/2	RD1450	30	\$184.92
3/4	RD1475	30	174.37

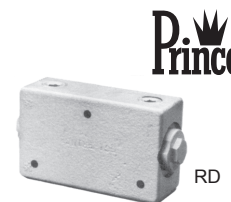

SINGLE ACTING - To Lock in ONE DIRECTION ONLY with a 4-way Valve

GRESEN 2500 PSI - SINGLE ACTING

Port Size	GRESEN Part Number	Max GPM Flow	Price Per Piece
1/2	LO-50-S	25	\$195.66



Prices subject to change without notice. **ASK FOR QUANTITY DISCOUNT**

1-800-228-9222 / e-mail: sales@baumhydraulics.com
 Fax: 1-800-832-2522 / www.baumhydraulics.com / © Baum Hydraulics Corporation

BAUM HYDRAULICS CORPORATION

LARGE HYDRAULIC RETURN LINE PAPER ELEMENT

A LARGE SIZE FULL-FLOW IN-LINE FILTER

USE - Install in return line between the control valve and the tank.

This full flow filter has a built-in by-pass valve which opens automatically when filter is clogged or overloaded. Dial indicator tells when filter is dirty. Filter element easily removed for replacement. Install filter at high point of system. Filter gives full-flow filtration until clogged with dirt.



**GRESEN
ASSEMBLY
1-1/4" PIPE
SPIN-ON**

GRESEN
Number GPM Our
Sequence
Number Price
Per Piece



**BAUM
ASSEMBLY
1-1/4" OR 1" PIPE
SPIN-ON**

BAUM
Number 1" Our
Sequence
Number GPM 1-1/4"
Sequence
Number 1" and 1-1/4"
Price
Per Piece



**BAUM
ASSEMBLY
1-1/2" PIPE
SPIN-ON**

GPM 1-1/2"
Our
Sequence
Number Price
Per Piece

FILTER ASSEMBLIES WITHOUT GAUGE PORTS

With FINE 10 Micron Paper Element

FSP212-1EDNH	65	345280	\$93.01	FSP212-1EDNN	Y94836	62	Y94864	\$45.15	62	Y94920	\$59.43
-----	--	----	FSP212-1EDNN Long	Y94838	70	Y94866	52.41	70	Y94922	66.70

With FINE 10 Micron Water Absorbing Paper Element

-----	--	----	FSP212-1EDNN-AZ Lg.	Y94840	28	Y94868	68.21	28	Y94924	82.50
-------	----	------	------	---------------------	--------	----	--------	-------	----	--------	-------

With COARSE 25 Micron Paper Element

FSP212-1JDNH	75	345310	93.01	FSP212-1JDNN	Y94842	70	Y94870	44.27	70	Y94926	58.55
-----	--	----	FSP212-1JDNN Long	Y94844	70	Y94872	52.41	78	Y94928	66.70

With EXTRA FINE 3 Micron Paper Element

FSP212-1ADNN	45	----	FSP212-1ADNN	Y94846	35	Y94874	45.72	35	Y94930	60.00
-----	--	----	FSP212-1ADNN Long	Y94848	40	Y94876	62.42	40	Y94932	76.71

With EXTRA FINE 3 Micron Water Absorbing Paper Element

-----	--	----	FSP212-1ADNN-AZ Lg.	Y94850	12	Y94878	69.05	12	Y94934	83.34
-------	----	------	------	---------------------	--------	----	--------	-------	----	--------	-------

FILTER ASSEMBLIES WITH GAUGE PORTS

With FINE 10 Micron Paper Element

FSP212-1EDNA	65	----	FSP212-1EDNAC	Y94986	62	Y95014	48.39	62	Y95070	59.73
-----	--	----	FSP212-1EDNAC Long	Y94988	70	Y95016	55.66	70	Y95072	67.00

With FINE 10 Micron Water Absorbing Element

-----	--	----	FSP212-1EDNAC	Y94990	28	Y95018	71.45	28	Y95074	82.80
-------	----	------	------	---------------	--------	----	--------	-------	----	--------	-------

With COARSE 25 Micron Paper Element

FSP212-1JDNA	75	----	FSP212-1JDNAC	Y94992	70	Y95020	47.51	70	Y95076	58.85
-----	--	----	FSP212-1JDNAC Long	Y94994	70	Y95022	55.66	78	Y95078	67.00

With EXTRA FINE 3 Micron Paper Element

FSP212-1ADNA	45	----	FSP212-1ADNAC	Y94996	35	Y95024	48.96	35	Y95080	60.30
-----	--	----	FSP212-1ADNAC Long	Y94998	40	Y95026	65.67	40	Y95082	77.01

With EXTRA FINE 3 Micron Water Absorbing Paper Element

-----	--	----	FSP212-1ADNAC-AZ Lg.	Y95000	12	Y95028	72.30	12	Y95084	83.64
-------	----	------	------	----------------------	--------	----	--------	-------	----	--------	-------

FILTER HEADS ONLY

Without Gauge Ports

-----	----	SF-100-25-0	501141	24.65	-----
-----	----	SF-120-25-0	501150	22.56	SF-150-25-0	501200 36.85

With Gauge Ports

-----	----	SF-100-25-1 & 3	501143	26.74	-----
-----	----	SF-120-25-1 & 3	501155	25.80	SF-150-25-1&3	501205 37.15

REPLACEMENT ELEMENTS

Fine 10 Micron Element

Standard	-----
Extra Long	-----
Water Absorbing	-----

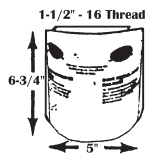

SE-10	501045	22.59
LE-10	501050	29.85
LE-10AZ	501055	45.65

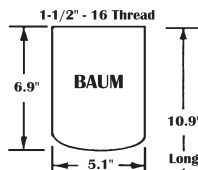

SE-10	501045	22.59
LE-10	501050	29.85
LE-10AZ	501055	45.65

Coarse 25 Micron Element

Standard	K-23019	345800	38.24
Extra Long	-----	----

SE-25	501060	21.71
LE-25	501065	29.85

SE-25	501060	21.71
LE-25	501065	29.85

Extra Fine 3 Micron Element

Standard	K-23020	345820	17.60
Extra Long	-----	----
Water Absorbing	-----	----

SE-3	501070	23.16
LE-3	501075	39.86
LE-03AZ	501080	46.49

SE-3	501070	23.16
LE-3	501075	39.86
LE-03AZ	501080	46.49

ASK FOR QUANTITY DISCOUNT

Prices subject to change without notice.

MEDIUM HYDRAULIC RETURN LINE PAPER ELEMENT OR WASHABLE SCREEN FILTER

AN ECONOMY MEDIUM SIZE RETURN-LINE FILTER

H19

USE - Install in return line between the control valve and the tank.

This full flow filter has a built-in by-pass valve which opens automatically when filter is clogged or overloaded. Dial indicator tells when filter is dirty. Filter element easily removed for replacement. Install filter at high point of system. Filter gives full-flow filtration until clogged with dirt.



GRESEN ASSEMBLY
3/4" PIPE SPIN-ON

GRESEN Number GPM Our Sequence Number Price Per Piece



BAUM ASSEMBLY
1/2" OR 3/4" PIPE SPIN-ON

1/2" Our Sequence Number GPM 3/4" Sequence Number 1/2" and 3/4" Price Per Piece



BAUM ASSEMBLY
1" PIPE SPIN-ON

GPM Our Sequence Number 1" Price Per Piece

FILTER ASSEMBLIES WITHOUT GAUGE PORTS

With FINE 10 Micron Paper Element

FSP107-1EDNN	23	344860	\$100.62	FSP107-1EDNN	Y94500	18	Y94520	\$24.09	18	Y94540	\$27.77
-----	--		FSP107-1EDNN Long	Y94502	25	Y94522	31.31	25	Y94542	34.98

With FINE 10 Micron Water Absorbing Paper Element

-----	--		FSP107-1EDNN-AZ	Y94504	7	Y94524	40.87	7	Y94544	44.54
-------	----	------	--	-----------------	--------	---	--------	-------	---	--------	-------

With COARSE 33 Micron or 25 Micron Paper Element

FSP107-1LDNN	27	344890	45.29	FSP107-1LDNN	Y94506	25	Y94526	24.09	25	Y94546	27.77
--------------	----	--------	-------	--------------	--------	----	--------	-------	----	--------	-------

With EXTRA FINE 3 Micron Paper Element

-----	--	FSP107-1ADNN-AZ	Y94508	10	Y94528	49.47	10	Y94548	53.14
-------	----	----	----	-----------------	--------	----	--------	-------	----	--------	-------

FILTER ASSEMBLIES WITH GAUGE PORTS

With FINE 10 Micron Paper Element

FSP107-1EDNA	23		FSP107-1EDNAC	Y94610	18	Y94630	25.28	18	Y94650	28.60
-----	--		FSP107-1EDNAC Long	Y94612	25	Y94632	32.50	25	Y94652	35.81

With FINE 10 Micron Water Absorbing Paper Element

-----	--		FSP107-1EDNAC-AZ	Y94614	7	Y94634	42.05	7	Y94654	45.37
-------	----	------	--	------------------	--------	---	--------	-------	---	--------	-------

With COARSE 33 Micron or 25 Micron Paper Element

FSP107-1LDNA	27		FSP107-1LDNAC	Y94616	25	Y94636	25.28	25	Y94656	28.60
--------------	----	------	--	---------------	--------	----	--------	-------	----	--------	-------

With EXTRA FINE 3 Micron Water Absorbing Paper Element

-----	--		FSP107-1ADNAC-AZ Lg.	Y94618	10	Y94638	50.65	10	Y94658	53.97
-------	----	------	--	----------------------	--------	----	--------	-------	----	--------	-------

FILTER HEADS ONLY

Without Gauge Ports

....	ZAF-05-50-0	501260	16.65
....	ZAF-07-25-0	501275	14.89
....	ZAF-10-25-0	501285	18.56

With Gauge Ports

....	ZAF-05-50-1 & 3	501262	17.40
....	ZAF-07-25-1 & 3	501280	16.07
....	ZAF-10-25-1 & 3	501290	19.39

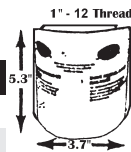

REPLACEMENT ELEMENTS

Fine 10 Micron Element

Standard	K-22001	345570	19.29
Extra Long	-----	
Water Absorbing	-----	

AE-10	501005	9.21
AE-10L	501010	16.42
AE-10AZ	501015	25.98

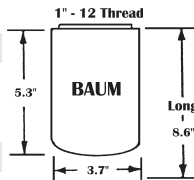

Coarse 25 Micron Element

Standard	K-22002	345600	17.74
----------	---------	--------	-------

AE-25	501020	9.21
-------	--------	------

Extra Fine 3 Micron Element

-----		
-------	------	--	--

AE-03AZL	501000	34.58
----------	--------	-------

HOW TO INSTALL FILTERS

Buy filters with an extra element. Install and operate filter for one hour to clean the oil, then change element. Install filter upright in high point of system. With Gresen filters, install casting first, then attach bottom allowing 1 inch clearance. Find arrow on casting for correct flow direction. Follow enclosed instructions to install and adjust dial indicator.

Install with the lower surface of the filter head casting above reservoir oil level so that when the filter housing is removed oil supply in reservoir will not drain.

Paper Element will filter three times as thoroughly as the Wire Cloth Element. Install filter at high point of the system.

GASKETS & SEALS for LARGE GRESEN FILTERS

Description	Part Number	O.D.	x	I.D.	x	Thickness	x	Height	Our Sequence Number	Price Per Piece
Gasket for FSP212 Series Filter	11872-001	5/16	x	4-17/32	x	1/4	x	5/16	360595	\$2.45
Flat Center Post Seal Between Can & Center on Bottom	1575-001	3-3/4	x	1-3/4	x	1	x	1/16	359500	2.46
Large Square Cut Housing Seal Between Can & Head	1576-001	4-3/4	x	4-3/8	x	3/16	x	1/4	359520	4.54

Prices subject to change without notice. **ASK FOR QUANTITY DISCOUNT**

1-800-228-9222 / e-mail: sales@baumhydraulics.com
Fax: 1-800-832-2522 / www.baumhydraulics.com / © Baum Hydraulics Corporation

BAUM HYDRAULICS CORPORATION

LARGE HYDRAULIC RETURN LINE PAPER ELEMENT

A LARGE SIZE FULL-FLOW IN-LINE FILTER

USE - Install in return line between the control valve and the tank.

This full flow filter has a built-in by-pass valve which opens automatically when filter is clogged or overloaded. Dial indicator tells when filter is dirty. Filter element easily removed for replacement. Install filter at high point of system. Filter gives full-flow filtration until clogged with dirt.

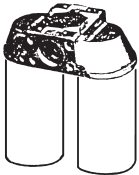

**BAUM ASSEMBLY SPIN-ON
SIDE-BY-SIDE**

200 PSI
2" Split Flange & 1-1/2"
Pipe Thd. Combination

BAUM Number	GPM	Our Sequence Number	Price Per Piece
-------------	-----	---------------------------	--------------------

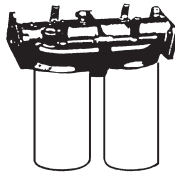

**BAUM ASSEMBLY SPIN-ON
MODULAR LINE**

200 PSI
2" Split Flange & 1-1/2"
Pipe Thd. Combination

BAUM Number	GPM	Our Sequence Number	Price Per Piece
-------------	-----	---------------------------	--------------------



**GRESEN ASSEMBLY SPIN-ON
DROP-IN**

200 PSI
1-1/2" Split Flange & 1-1/4"
NPTF Combination

GRESEN Number	GPM	Our Sequence Number	Price Per Piece
---------------	-----	---------------------------	--------------------

FILTER ASSEMBLIES WITHOUT GAUGE PORTS

With FINE 10 Micron Paper Element

FSP415-5EDNNK	108	Y95136	\$152.19	FSP615-5EDNNK	128	Y95268	\$140.82	-----	--	\$....
FSP415-5EDNNK Long	110	Y95138	166.73	FSP615-5EDNNK Long	138	Y95270	155.36	-----	--

With FINE 10 Micron Water Absorbing Element

FSP415-5EDNNK-LAZ	38	Y95140	198.32	FSP615-5EDNNK-LAZ	40	Y95272	186.95	-----	--
-------------------	----	--------	--------	-------------------	----	--------	--------	-------	----	------

With COARSE 25 Micron Paper Element

FSP415-5LDNNK	115	Y95142	150.43	FSP615-5LDNNK	132	Y95274	139.06	FLR215-9LDNH	84	345180
FSP415-5LDNNK Long	130	Y95144	166.73	FSP615-5LDNNK Long	142	Y95276	155.36	-----	--	

With EXTRA FINE 3 Micron Paper Element

FSP415-5ADNNK	85	Y95146	153.33	FSP615-5ADNNK	95	Y95278	141.96	-----	--
FSP415-5ADNNK Long	90	Y95148	186.75	FSP615-5ADNNK Long	105	Y95280	175.38	-----	--

With EXTRA FINE 3 Micron Paper Water Absorbing Element

FSP415-5ADNNK-LAZ	25	Y95150	200.00	FSP615-5ADNNK-LAZ	30	Y95282	188.64	-----	--
-------------------	----	--------	--------	-------------------	----	--------	--------	-------	----	------

FILTER ASSEMBLIES WITH GAUGE PORTS

With FINE 10 Micron Paper Element

FSP415-5EDNACK	108	Y95202	162.12	FSP615-5EDNACK	130	Y95334	144.87	-----	--
FSP415-5EDNACK Long	110	Y95204	176.66	FSP615-5EDNACK Long	140	Y95336	159.41	-----	--

With FINE 10 Micron Water Absorbing Element

FSP415-5EDNACK-LAZ	38	Y95206	208.25	FSP615-5EDNACK-LAZ	40	Y95338	191.00	-----	--
--------------------	----	--------	--------	--------------------	----	--------	--------	-------	----	------

With COARSE 25 Micron Paper Element

FSP415-5LDNACK	115	Y95208	160.36	FSP615-5LDNACK	132	Y95340	143.11	FLR215-9LDNH	84	345180
FSP415-5LDNACK Long	130	Y95210	176.66	FSP615-5LDNACK Long	142	Y95342	159.41	-----	--	

With EXTRA FINE 3 Micron Paper Element

FSP415-5ADNACK	85	Y95212	163.26	FSP615-5ADNACK	95	Y95344	146.01	-----	--
FSP415-5ADNACK Long	90	Y95214	196.68	FSP615-5ADNACK Long	105	Y95346	179.43	-----	--

With EXTRA FINE 3 Micron Paper Water Absorbing Element

FSP415-5ADNACK-LAZ	25	Y95216	209.94	FSP615-5ADNACK-LAZ	30	Y95348	192.68	-----	--
--------------------	----	--------	--------	--------------------	----	--------	--------	-------	----	------

FILTER HEAD ONLY

Without Gauge Ports

ZDF-2215-25-0-00	501335	107.02	MF-2215-25-0-2-0	501250	95.65	-----
------------------	--------	--------	------------------	--------	-------	-------	------

With Gauge Ports

ZDF-2215-25-1 & 3-00	501340	116.95	MF-2215-25-1 & 3-2-0	501255	99.70	-----
----------------------	--------	--------	----------------------	--------	-------	-------	------

REPLACEMENT ELEMENTS

Fine 10 Micron Element								
Standard SE-10	501045	22.59	SE-10	501045	22.59	K-23026	345765	33.11
Extra Long LE-10	501050	29.85	LE-10	501050	29.85	-----	-----
Water Absorb. LE-10AZ	501055	45.65	LE-10AZ	501055	45.65	-----	-----
Coarse 25 Micron Element								
Standard SE-25	501060	21.71	SE-25	501060	21.71	K-23027	345735	31.58
Extra Long LE-25	501065	29.85	LE-25	501065	29.85	-----	-----
Extra Fine 3 Micron Element								
Standard SE-3	501070	23.16	SE-3	501070	23.16	K-23044	345850	25.38
Extra Long LE-3	501075	39.86	LE-3	501075	39.86	-----	-----
Water Absorb. LE-03AZ	501000	34.58	LE-03AZ	501000	34.58	-----	-----

ASK FOR QUANTITY DISCOUNT

Prices subject to change without notice.

MEDIUM HYDRAULIC SUCTION LINE SPIN-ON SCREEN FILTER



USE-Install in the suction line between pump inlet and the tank except Sump type, which is installed in the tank. This full flow filter has a built-in by-pass valve which opens automatically when filter is clogged or overloaded. Dial indicator tells when filter is dirty. Filter element easily removed for replacement. Filter gives full-flow filtration until clogged with dirt.

BAUM ASSEMBLY 1/2" OR 3/4" OR 1" PIPE SPIN-ON

1/2"		3/4"		1"							
BAUM Number	GPM	Our Sequence Number	Price Per Piece	BAUM Number	GPM	Our Sequence Number	Price Per Piece	BAUM Number	GPM	Our Sequence Number	Price Per Piece
FILTER ASSEMBLIES WITHOUT GAUGE PORTS											
With Coarse 100 Mesh Wire Screen Element 91 Square Inch 141 Micron											
FSP107-1XDNN	5	Y94510	\$45.22	FSP107-1XDNN	9	Y94530	\$45.55	FSP107-1XDNN	14	Y94550	\$49.05
FILTER ASSEMBLIES WITH GAUGE PORTS											
Filter with COARSE 100 Mesh Screen Element 91 Square Inch 141 Micron											
FSP107-1XDNAC	5	Y94620	48.37	FSP107-1XDNAC	9	Y94640	47.51	FSP107-1XDNAC	14	Y94660	50.83
FILTER HEAD ONLY											
ZAF-05-05-0 Without Gauge Ports			501264	13.78	ZAF-05-05-5 With Gauge Ports			501266			16.93
ZAF-07-05-0 Without Gauge Ports			501281	14.11	ZAF-07-05-5 With Gauge Ports			501270			16.07
ZAF-10-05-0 Without Gauge Ports			501283	17.61	ZAF-10-05-5 With Gauge Ports			501284			19.39
REPLACEMENT ELEMENTS											
100 Mesh Element for 1/2", 3/4" and 1" Medium Assemblies											
AE-100			501025	31.44						

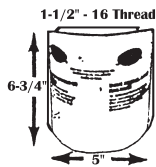

LARGE HYDRAULIC SUCTION LINE SPIN-ON SCREEN FILTER

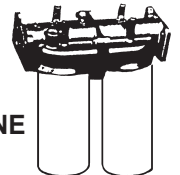

BAUM ASSEMBLY TWIN SIDE-BY-SIDE
2" Split Flange & 1-1/2" Pipe Thd. Combination

BAUM ASSEMBLY IN-LINE MODULAR LINE
2" Split Flange & 1-1/2" Pipe Thd. Combination

BAUM TWIN SIDE BY SIDE				BAUM TWIN IN-LINE				
Number	GPM	Our Sequence Number	Price Per Piece	Number	GPM	Our Sequence Number	Price Per Piece	
FILTER ASSEMBLIES WITHOUT GAUGE PORTS								
Filter with 2 COARSE 100 Mesh Screen Element 200 Square Inch Each 141 Micron								
FSP415-5SBNNK	50	Y95164	\$205.56	FSP615-5SBNNK	50	Y95296	\$189.65	
Filter with 2 COARSE EXTRA LARGE 100 Mesh Wire Screen Element 380 Square Inch Each 141 Micron								
FSP415-5TBNNK	64	Y95166	246.71					
FILTER ASSEMBLIES WITH GAUGE PORTS								
Filter with 2 COARSE 100 Mesh Screen Element 200 Square Inch Each 141 Micron								
FSP415-5SBNEK	50	Y95230	207.34	FSP615-5SBNEK	50	Y95362	191.38	
Filter with 2 COARSE EXTRA LARGE 100 Mesh Wire Screen Element 380 Square Inch Each 141 Micron								
FSP415-5TBNEK	64	Y95232	248.49	FSP615-5TBNEK	64	Y95364	232.52	
FILTER HEAD ONLY								
ZDF-2215-05-0-00 Without Gauge Ports			501310	107.02	MF-2215-05-0-2-0 Without Gauge Ports		501225	91.11
ZDF-2215-05-5-00 With Gauge Ports			501315	108.80	MF-2215-05-5-2-0 With Gauge Ports		501230	92.84
REPLACEMENT ELEMENTS								
With 100 Mesh Element		1-1/2" - 16 Thread						
Standard SE-100		501085	49.27	Standard SE-100		501085	49.27	
Extra Long LE-100		501090	69.84	Extra Long LE-100		501090	69.84	

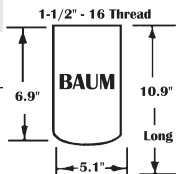

GASKETS & SEALS for LARGE GRESN FILTERS

Description	Part Number	O.D.	x	I.D.	x	Thickness	x	Height	Our Sequence Number	Price Per Piece
Gasket for FSP212 Series Filter	11872-001	5/16	x	4-17/32	x	1/4	x	5/16	360595	\$2.45
Flat Center Post Seal Between Can & Center on Bottom	1575-001	3-3/4	x	1-3/4	x	1	x	1/16	359500	2.46
Large Square Cut Housing Seal Between Can & Head	1576-001	4-3/4	x	4-3/8	x	3/16	x	1/4	359520	4.54

Prices subject to change without notice. **ASK FOR QUANTITY DISCOUNT**

1-800-228-9222 / e-mail: sales@baumhydraulics.com
Fax: 1-800-832-2522 / www.baumhydraulics.com / © Baum Hydraulics Corporation



LARGE HYDRAULIC SUCTION LINE WASHABLE SCREEN FILTER A LARGE SIZE FULL-FLOW IN-LINE FILTER

USE-Install in the suction line between pump inlet and the tank except Sump type, which is installed in the tank.
This full flow filter has a built-in by-pass valve which opens automatically when filter is clogged or overloaded. Dial indicator tells when filter is dirty.
Filter element easily removed for replacement. Filter gives full-flow filtration until clogged with dirt.



BAUM ASSEMBLY LARGE SUCTION SPIN-ON

1", 1-1/4" & 1-1/2" Pipe Thread
Large Suction



**GRESEN ASSEMBLY
DROP-IN**

1-1/2" Split Flange & 1-1/4"
Pipe Thd Combination
Drop-In

BAUM Spin-On Number	GPM	1" Sequence Number	GPM	1-1/4" Sequence Number	GPM	1-1/2" Sequence Number	Price Per Piece	GRESEN Drop-In Number	GPM	Our Sequence Number	Price Per Piece
---------------------	-----	--------------------	-----	------------------------	-----	------------------------	-----------------	-----------------------	-----	---------------------	-----------------

FILTER ASSEMBLIES WITHOUT GAUGE PORTS

Filter with COARSE 100 Mesh Screen Element 200 Square Inch 141 Micron											
FSP112-1SBNN	15	Y94662	25	Y94720	32	Y94744	\$86.12	-----	--		\$....
Filter with COARSE EXTRA LARGE 100 Mesh Wire Screen Element 380 Square Inch 141 Micron											
FSP112-1TBNN	18	Y94664	30	Y94722	40	Y94746	106.69	-----	--	

FILTER ASSEMBLIES WITH GAUGE PORTS

Filter with COARSE 100 Mesh Screen Element 200 Square Inch 141 Micron											
FSP112-1SBNDF	15	Y94666	25	Y94778	32	Y94802	88.20	-----	--	
Filter with COARSE EXTRA LARGE 100 Mesh Wire Screen Element 380 Square Inch 141 Micron											
FSP112-1TBNDF	18	Y94668	30	Y94780	40	Y94804	108.78	-----	--	
With EXTRA COARSE 60 Mesh Screen Element 220 Micron (K-23011)											
-----							-----	--	

BAUM Number	Size	Our Sequence Number	Price Per Piece	GRESEN Number	Size	Our Sequence Number	Price Per Piece
-------------	------	---------------------	-----------------	---------------	------	---------------------	-----------------

FILTER HEAD ONLY

Without Gauge Ports							
SF-100-05-0	1"	501130	23.47				
SF-120-05-0	1-1/4"	501145	23.72				
SF-150-05-0	1-1/2"	501175	36.85	-----		
With Gauge Ports							
SF-100-05-4 & 6	1"	501132	26.74				
SF-120-05-4 & 6	1-1/4"	501147	24.62				
SF-150-05-4 & 6	1-1/2"	501180	38.93	-----		

REPLACEMENT ELEMENTS

With 100 Mesh Element								
Standard	SE-100		501085	49.27	Standard	K-25001	345940	20.36
Extra Long	LE-100		501090	69.84	-----	-----	-----	--
-----	-----		-----	Extra Heavy	K-25002	345950	70.42
With 60 Mesh Element								
-----	-----		-----	-----	K-23001	345700	39.58

NOTE: Filter assemblies using 100 mesh wire screen element for suction line should use the filter head with the 5 PSI bypass spring setting. Those with gage ports need the proper gage port location for a vacuum gage.

GASKETS & SEALS for LARGE GRESEN FILTERS

Description	Part Number	O.D.	x	I.D.	x	Thickness	x	Height	Our Sequence Number	Price Per Piece
Gasket for FSP212 Series Filter	11872-001	5/16	x	4-17/32	x	1/4	x	5/16	360595	\$2.45
Flat Center Post Seal Between Can & Center on Bottom	1575-001	3-3/4	x	1-3/4	x	1	x	1/16	359500	2.46
Large Square Cut Housing Seal Between Can & Head	1576-001	4-3/4	x	4-3/8	x	3/16	x	1/4	359520	4.54

ASK FOR QUANTITY DISCOUNT Prices subject to change without notice.

FLOW EZY TANK-MOUNTED SUCTION STRAINERS; RETURN LINE STRAINERS; & DIFFUSERS

TANK-MOUNTED STRAINERS

This is an easy way to put a strainer to work at your tank or reservoir. Mount them through the side wall, or through the top, into a standpipe. Either way they can be removed through the hole in which they are mounted, for easy servicing. Access to the tank interior is never necessary. Made in two styles: Suction line models are used when drawing fluid from the tank. Return line models are used when sending fluid into the tank.

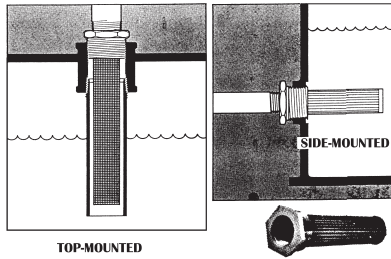

Part Number	Tank Bushing	Female Pipe	GPM	Length	Diam.	Price Per Piece
SUCTION STRAINERS - 60 MESH						
S5-60	1	1/2	5	5-5/16	7/8	\$24.05
S10-60	1-1/4	3/4	10	8	1-1/8	29.71
S15-60	1-1/2	1	15	8-1/2	1-1/4	35.54
S25-60	2	1-1/4	25	9-9/16	1-9/16	40.67
RETURN FILTERS - 100 MESH						
R-19-100	1	1/2	18	5-5/16	7/8	22.46
R-33-100	1-1/4	3/4	32	8	1-1/8	28.48
R-54-100	1-1/2	1	53	8-1/2	1-1/4	35.56
R-94-100	2	1-1/4	93	9-9/16	1-9/16	40.67
DIFFUSERS						
D34	1-1/4	3/4	34	8	1-1/8	38.55
D55	1-1/2	1	55	8-1/2	1-1/4	39.61

By assembling the pipe fittings listed in the table you build a housing into which the Flow Ezy strainer fits.



DIMENSIONS AND SUPPLIES

Strainer Model Size	Bushing Size	Length	Assembled Length (Approx.)	Pipe Size
S-5	1 x 1/2	5-5/16	7	1/2
S-10	1-1/4 x 3/4	8	10	3/4
S-15	1-1/2 x 1	8-1/2	11	1
S-25	2 x 1-1/4	9-9/16	13	1-1/4

PLUMBING SUPPLIES REQUIRED

For Strainer Model	Nipple (1 Required)	Coupling (2 Required)	Bushing (1 Required)
S-5	1-1/4 x 3-1/2	1-1/4 x 1	1 x 3/4
S-10	1-1/2 x 6	1-1/2 x 1-1/4	1-1/4 x 3/4
S-15	2 x 5-1/2	2 x 1-1/2	1-1/2 x 1
S-25	2-1/2 x 7	2-1/2 x 2	2 x 1-1/4

FLOW EZY SUMP STRAINER

Flow Ezy Sump Strainer with Male Pipe Threads

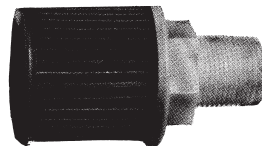

Part Number	Male Pipe	GPM	Length	Diam.	Price Per Piece
Nylon-End Nipple Style Flow Ezy Sump Strainer - 60 Mesh					
P-3 3/4-60	3/4	3	3-5/8	2-1/8	\$17.15
P-50-2	2	50	11-1/4	4-3/16	52.34
P-75-2-1/2	2-1/2	75	13-3/4	5-3/16	55.88
P-100-3	3	100	13-3/4	5-3/16	66.13

SUMP FILTER with Female Pipe Threads

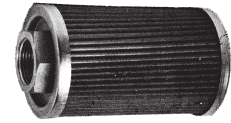

Part Number	Female Pipe	GPM	Length	Diam.	Price Per Piece
GRESEN Sump Filter - 100 Mesh - 149 Micron					
FST215-1TB	1-1/4	30	9-7/8	4-1/3	\$118.93
FLOW EZY All Metal Sump with Female Pipe Threads					
10-1-100	1	10	5-3/4	3-9/32	32.54
20-1-1/4-100	1-1/4	20	7-3/8	3-9/32	38.03
30-1-1/2-100	1-1/2	30	9-1/8	4-9/32	63.30
50-2-100	2	50	9-3/4	4-9/32	85.42
75-2-1/2-100	2-1/2	75	12-1/2	5-7/16	107.16
100-3-100	3	100	12-1/2	5-7/16	139.53
FLOW EZY All Metal Sump Strainers with Relief Set at 3 Lbs. - 100 Mesh					
10-1-100-RV3	1	10	5-3/4	3-9/32	35.37
20-1-1/4x100-RV3	1-1/4	20	7-3/8	3-9/32	43.69
30-1-1/2-100-RV3	1-1/2	30	9-1/8	4-9/32	75.87
50-2-100-RV3	2	50	9-3/4	4-9/32	108.57
75-2-1/2-100-RV3	2-1/2	75	12-1/2	5-7/16	123.07
100-3-100-RV3	3	100	12-1/2	5-7/16	149.95

FLOW EZY RETURN LINE DIFFUSER

Female Pipe Thread or Male Nipple Pipe Thread Screws on or screws in (nipple design).

Flow diffusers help to cure foaming problems & to prevent cavitation caused by flow disturbance at the pump inlet. These units allow greater freedom in reservoir design, and may even eliminate the need for tank baffling plates. They also reduce reservoir noise. All-steel construction, and may be ordered with nut or nipple connector.

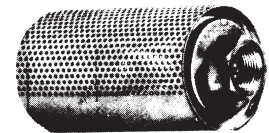

Part Number	Pipe Pipe	GPM	Length	Diam.	Price Per Piece
High Speed Return Line Flow Diffuser					
D-33 Female	3/4F	33	3-1/2	3-3/16	\$30.41
D-33 Nipple	3/4M	33	4-5/16	3-3/16	32.54
D-54 Female	1F	54	5-3/8	3-3/16	37.49
D-54 Nipple	1M	54	6-9/16	3-3/16	39.61
D-94 Female	1-1/4F	94	7-3/16	3-3/16	45.97

MAGNETIC DRAIN PLUGS

Plugs are square head not hex head as pictured.

Size Inches	Our Sequence Number	Price Per Piece
-------------	---------------------	-----------------

With Male Square head & Extended Magnet

1/8	146060	\$4.18
1/4	146063	3.97
3/8	146066	4.15
1-1/2	146081	\$24.33
2	146083	31.84

With Male Square head & Flush Magnet

1/2	146069	2.15
3/4	146072	3.00
1	146075	8.21
1-1/4	146078	13.75

With Male Hex head

1/2-ORB	146086	5.27
3/4-ORB	146092	6.33

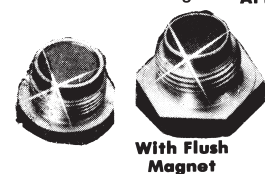
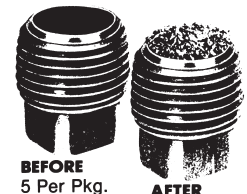

Prices subject to change without notice. **ASK FOR QUANTITY DISCOUNT**



213.53



111.10

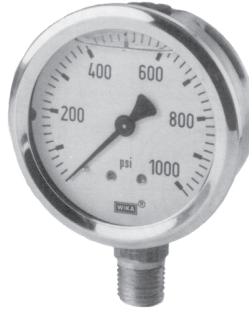

2-1/2" Round Face, Stainless Body, 1/4" NPT (Male Brass Fitting), Dual Scale (PSI & kg/cm²), Lower Mount.

Accuracy: Scale:	2-1/2" Gauge 1/4" NPT Oil Filled Stainless Steel Case			2-1/2" Gauge 1/4" NP Dry Gauge Plastic Case			4" Gauge 1/4" NPT Oil Filled Stainless Steel Case		
	1.5% Single	Our Sequence Number	Price Per Piece	1.5% Dual	Our Sequence Number	Price Per Piece	1.5% Single	Our Sequence Number	Price Per Piece

LM - LOWER MOUNT

PSI	213.53	Our Sequence Number	Price Per Piece	111.10	Our Sequence Number	Price Per Piece	213.53	Our Sequence Number	Price Per Piece
30 HG VAC	213.53	587396	\$52.15	111.10	587355	\$31.75	-----	-----	\$....
30 PSI	213.53	587397	42.90	111.10	587356	26.33	-----	-----
60 PSI	213.53	587398	45.19	111.10	587357	29.22	-----	-----
100 PSI	213.53	587399	42.90	111.10	587359	27.14	-----	-----
200 PSI	213.53	587400	42.90	111.10	587360	28.81	-----	-----
300 PSI	213.53	587401	42.90	111.10	587361	28.81	-----	-----
400 PSI	213.53	587402	41.59	-----	-----	-----	-----
600 PSI	213.53	587403	42.90	111.10	587363	26.06	-----	-----
1000 PSI	213.53	587404	42.90	-----	-----	-----	-----
1500 PSI	213.53	587405	47.67	111.10	587365	28.01	-----	-----
2000 PSI	213.53	587406	49.86	-----	-----	-----	-----
3000 PSI	213.53	587407	47.67	111.10	587367	33.91	213.53	587428	114.61
5000 PSI	213.53	587408	51.35	111.10	587368	36.23	213.53	587429	108.72
10000 PSI	213.53	587409	61.21	-----	-----	213.53	587430	158.23

PSI	Model Number	Price Per Piece
0 - 600 PSI	WLGS-600	\$14.48
0 - 1000 PSI	WLGS-1000	\$14.48
0 - 2000 PSI	WLGS-2000	\$14.48
0 - 3000 PSI	WLGS-3000	\$14.48
0 - 5000 PSI	WLGS-5000	\$....

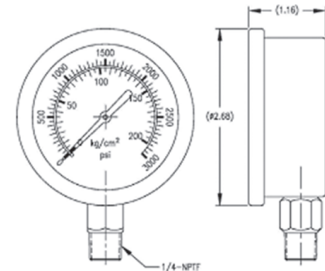

CBM - CENTER BACK MOUNT

PSI	213.53	Our Sequence Number	Price Per Piece	111.12	Our Sequence Number	Price Per Piece
30 PSI	-----	-----	111.12	5873725	27.16
400 PSI	-----	-----	111.12	587378	27.16
1500 PSI	213.53	587418	53.00	-----	-----
3000 PSI	213.53	587420	53.21	111.12	587387	32.26
5000 PSI	213.53	587421	49.51	-----	-----

RETURN & SUCTION FILTER GAUGES for BAUM, GRESN, PRINCE and CROSS FILTERS

For Baum, Gresen, Prince & Cross Filter, 1/8" NPT Center Back Mount 2" Diameter

Filter Gauge

Part Number	Our Sequence Number	Price Per Piece
Return Filter Gauge-60 PSI		
CI-20	501360	\$12.53
Suction Filter Gauge-30" HG Vacuum		
GV-10	501370	12.53

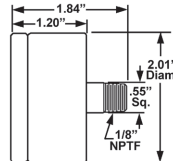
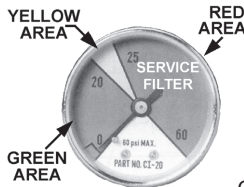

CI-20 - For use with 25 PSI filter by-pass valve

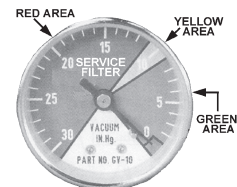

GV-10 - For use with 5 PSI filter by-pass valve

ASK FOR QUANTITY DISCOUNT Prices subject to change without notice.